



Ref.: 1330-TQ



Ref.:1605



Rei Vidros
DISTRIBUIDORA
Vidros, alumínio e ferragens



Ref.:1331-TQ



QUEM SOMOS NÓS? SOMOS A REI VIDROS

NO INÍCIO EM 1983 EM BUSCA DE NOVOS DESAFIOS E TAMBÉM COM GARRA DE MUDANÇA DE VIDA INICIAVA ALI A CENTER BOX ONDE, QUE NO INÍCIO SE ESPECIALIZAVA EM INSTALAÇÃO DE BOX DE ACRÍLICO, GRADES DE PROTEÇÃO DE ALUMÍNIO E PORTAS E JANELA DE ALUMÍNIO NO DECORRER DESSA HISTÓRIA POR SENTIDO DE EVOLUÇÃO A EMPRESA EVOLUIU O SEU PORTFÓLIO DE PRODUTOS E ATUAÇÃO NO MERCADO VIDREIRO E EM 2011 JUNTO COM ESSAS MUDANÇAS TAMBÉM TIVEMOS A TRANSIÇÃO DE NOME E AGORA NOSSA EMPRESA EM BUSCA DE SER A MELHOR EMPRESA DO SEGUIMENTO E LIDERAR PASSOU A SE CHAMAR REIVIDROS DISTRIBUIDORA, DE 2011 ATÉ 2019 NOS EVOLUIMOS MUDAMOS ENDEREÇO DE NOSSA CEDEE ESTAMOS CADA DIA MAIS BUSCANDO APERFEIÇOAMENTO NO MERCADO, E ESTAMOS MUITOS SATISFEITO COM OS RESULTADOS E QUEREMOS EVOLUIR CADA DIA MAIS.

Índice

Use cola rápida tipo (super bonder) nas cortiças, para agilizar a montagem das ferragens.



4 Ferragens Especias



12 Linha Santa Marina



58 Fechaduras Linha 3000



64 Puxadores e Acessórios



66 Linha Maxim-Ar

Ref.: 1009-TQ

Pivô para peças pivotantes superior / inferior

Obs: Montagem Simplificada



Ref.: 1013-TQ

Pivô para dobradiça inferior (montagem com a 1103-TQ)

Obs: Mais praticidade e agilidade na instalação (apenas 1 furo)

Parafuso em aço Inox

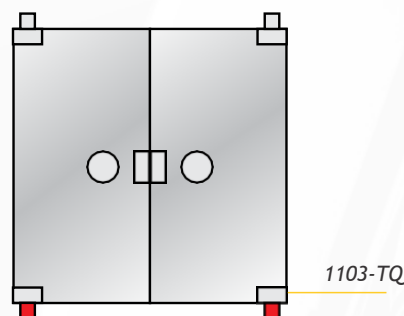
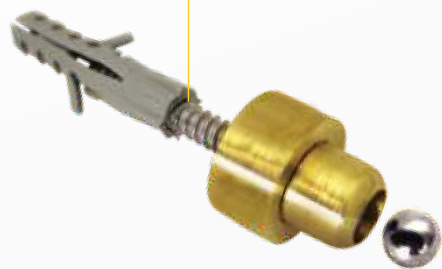

Ref.: 1101-TQ

Dobradiça superior com furo (montagem com a 1201-TQ)

Obs: Montagem Simplificada



Aplicação

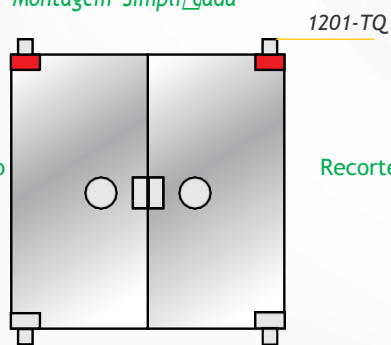

Recorte

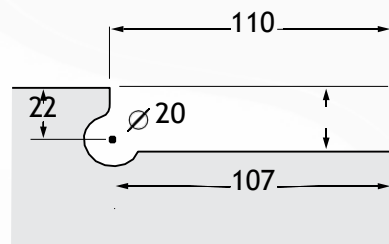

Ref.: 1103-TQ

Dobradiça Inferior com furo (montagem com a 1013-TQ)

Obs: Montagem Simplificada



Aplicação

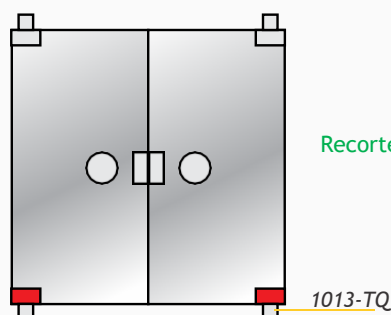

Recorte

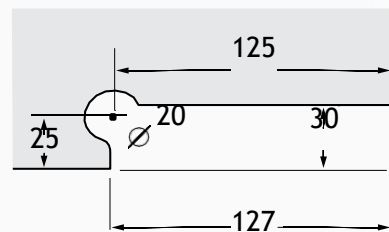

Ref.: 1101-BIG

Dobradiça superior vertical



Aplicação

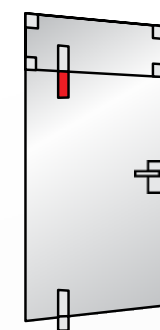

Recorte

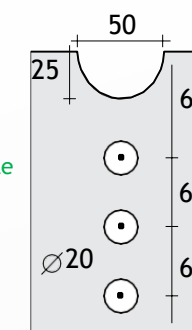

Ref.: 1103-BIG (Montagem com a 1013)

Dobradiça Inferior vertical



Aplicação



Recorte

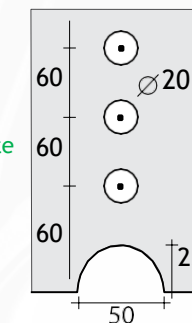

Ref.: 1201-BIG-V

Pivô para dobradiça 1101-big (VV)



Aplicação

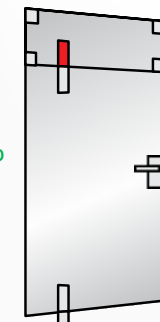

Recorte

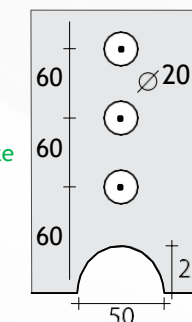

Ref.: 1201-BIG

Pivô para dobradiça 1101 BIG Vidro Alvenaria



Ref.: 1103-TQ-Rodapé

Dobradiça inferior com desconto para rodapé até 25mm



Aplicação

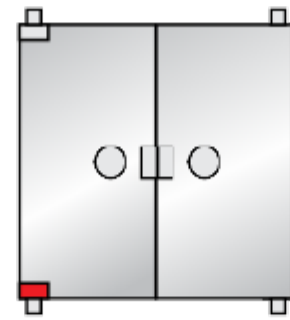

Recorte

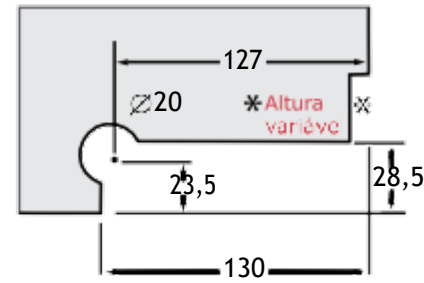

Ref.: 1114-TQ

Dobradiça automática para box (aberta/fechada) para requadro com veda poeira *Obs: dispensa o recorte do veda poeira*



Aplicação

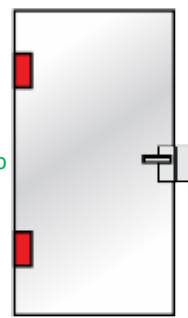

Recorte

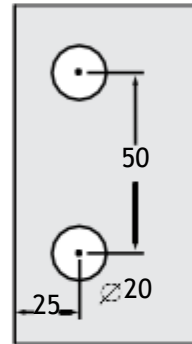

Ref.: 1125-TQ

Roldana Compensadora



Aplicação



Recorte

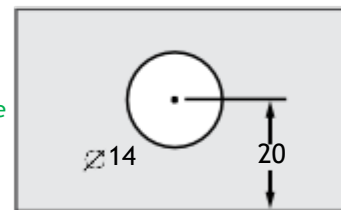

Ref.: 1125-LM

Roldana para vidro laminado de 8mm (cabecote varanda normal)



Ref.: 1125-MC-TQ

Mini carrinho com roldana côncava para armário e varanda

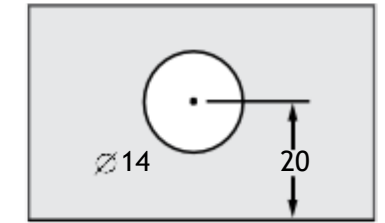
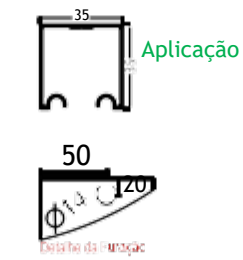

Ref.: 1126-DCP

Carrinho duplo com roldana côncava para trilho no piso

Aplicação

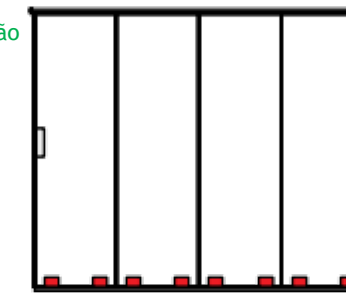

Recorte

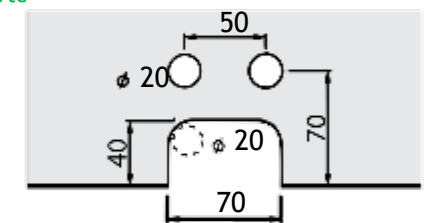

Ref.: 1201-TQ

Pino para pivô de dobradiça (simplificada)



Aplicação

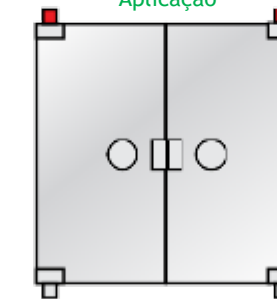

Recorte

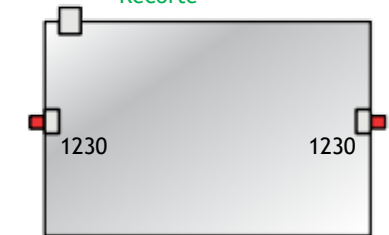

Ref.: 1201-SG

Pino para pivô de dobradiça



Aplicação

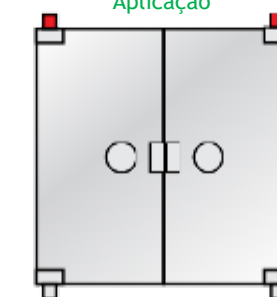

Recorte

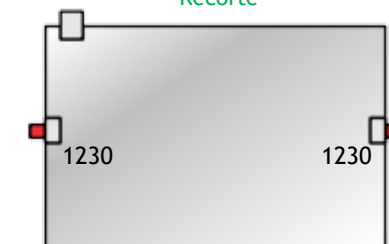

Ref.: 1231-TQ

Dobradiça pivotante inferior com trinco esquerdo / direito

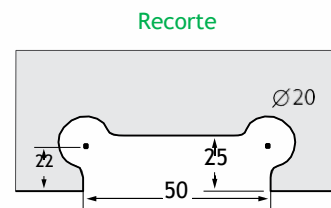
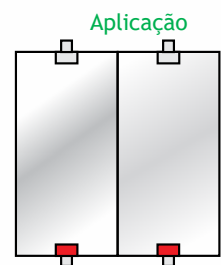

Ref.: 1335-TQ

Trinco para conjugar com veda-poeira

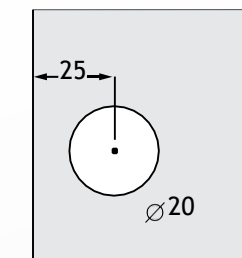
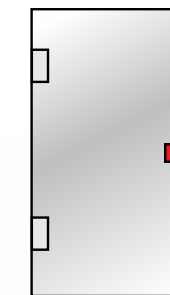

Ref.: 1306-TQ

Suporte com miolo para união de dois vidros com roldana côncava para porta sanfonada

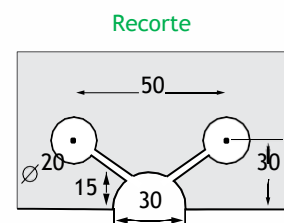
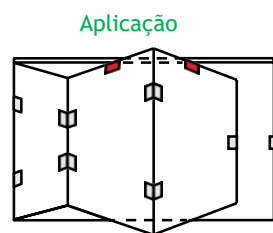

Ref.: 1507-TQ-E

Fechadura com maçaneta especial para porta de bater

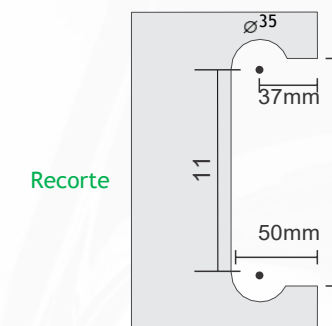
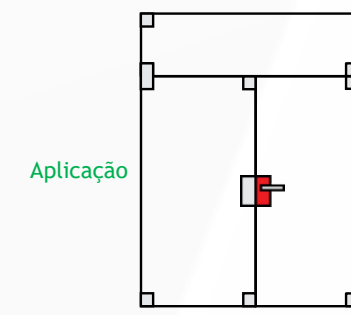

Ref.: 1330-TQ

Suporte para trinco em guarda-corpo

Obs: dispensa recorte, mais aderência no vidro e facilita produção do vidro.

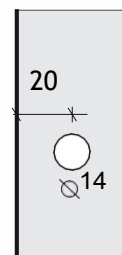
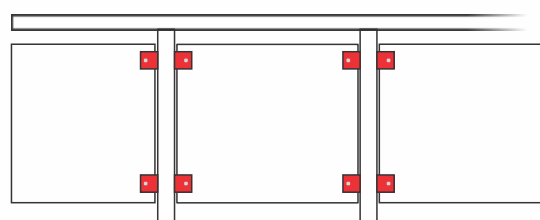

Ref.: 1507-TQ-S

Fechadura com maçaneta simples para porta de bater

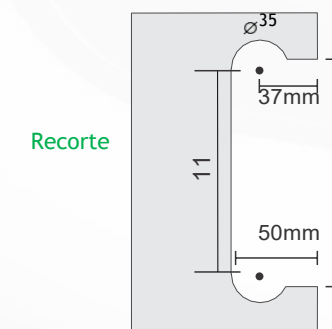
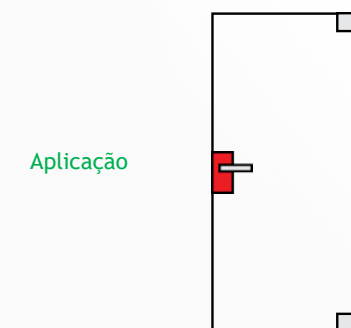

Ref.: 1331-TQ

Torre para guarda-corpo

Obs: Alumínio maciço

Tamanhos: 30cm, 40cm e 50cm

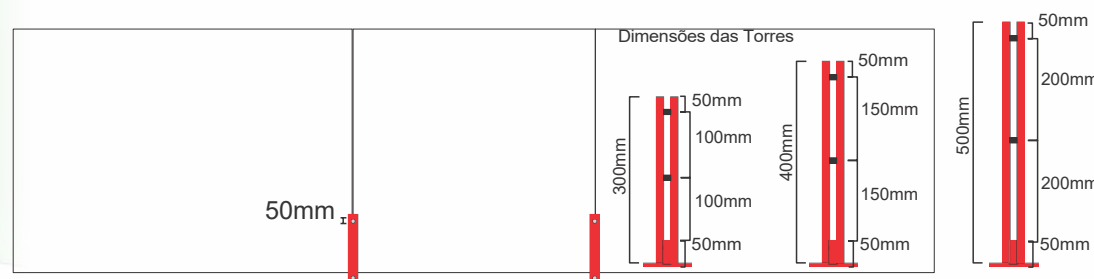

Ref.: 1507-WC-TQ-E

Fechadura com maçaneta para banheiro

Obs: chave apenas pelo lado externo

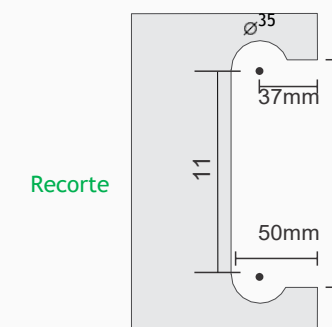



Ref.: 1508-TQ
Contra Fechadura para 1507-TQ vidro / vidro

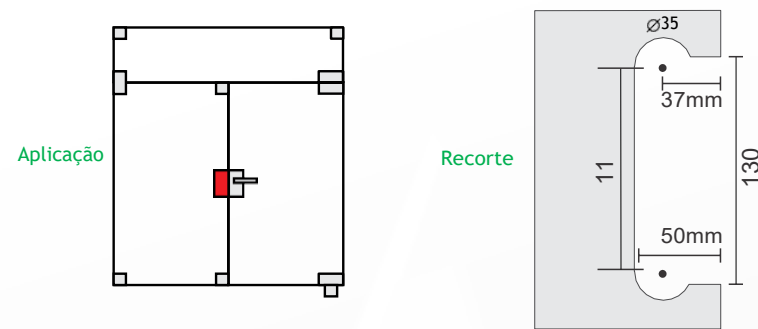

Ref.: 1570-TQ
Bate-Fecha - fecho para janelas vidro/vidro

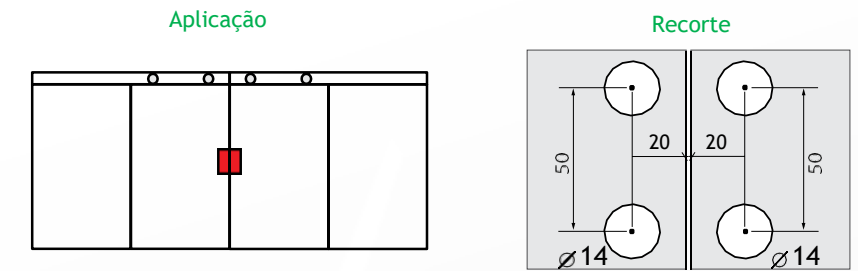

Ref.: 1509-TQ
Espelho para 1507-TQ

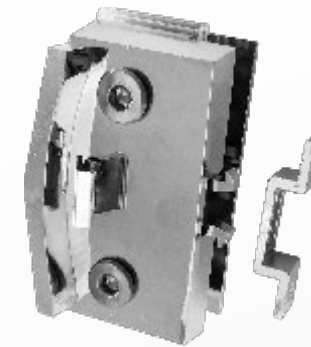
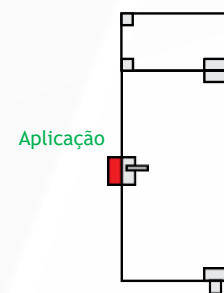

Ref.: 1571-TQ
Bate-fecha - Fecho para Janela vidro / alvenaria

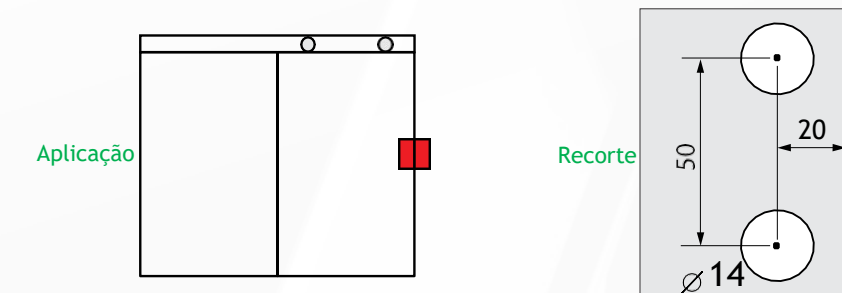

Ref.: 1529-BPX
Trinco para porta de banheiro com puxador

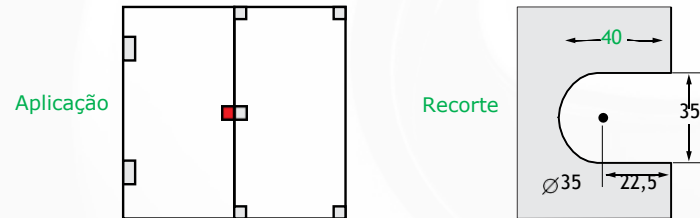

Ref.: 1710-TQ
Conjunto mão de amigo

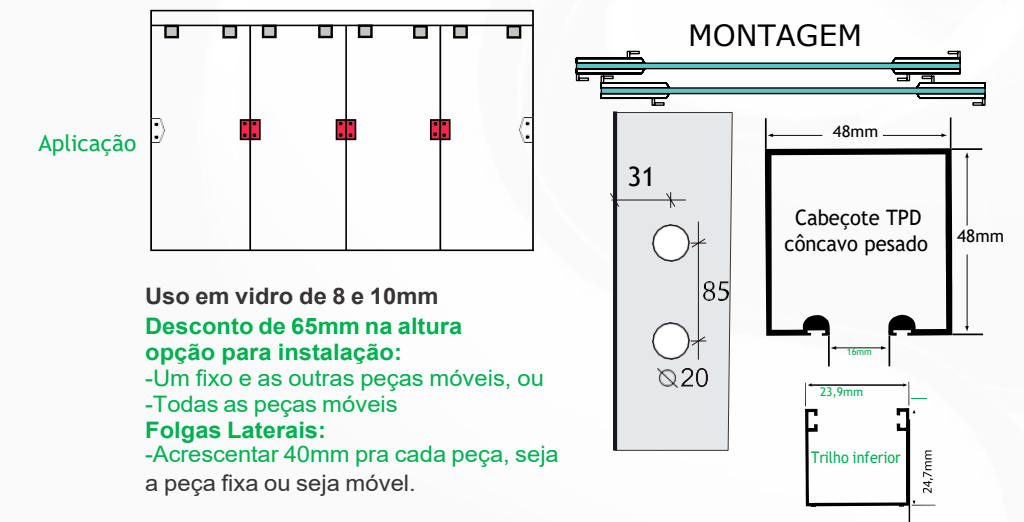

Uso em vidro de 8 e 10mm
Desconto de 65mm na altura
opção para instalação:
-Um fixo e as outras peças móveis, ou
-Todas as peças móveis
Folgas Laterais:
-Acrescentar 40mm pra cada peça, seja a peça fixa ou seja móvel.



Ref.: 1529-FC-D e 1529-FC-E
Fechadura para porta de box de bater direita / esquerda vidro / vidro - montagem com a 3211-M Vidro / alvenaria - montagem com a 3230-M

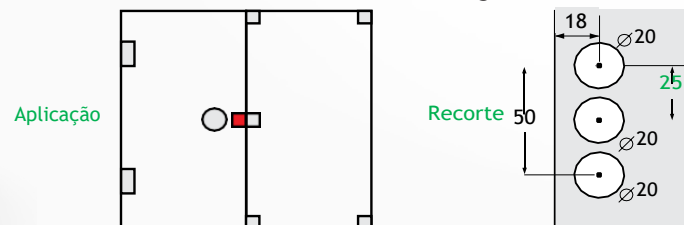

Ref.: 1125-RD / 1125-RE
Rodízio excêntrico para mesa de marcação direito / esquerdo
Obs: Fazer a instalação intercalando uma direita e outra esquerda

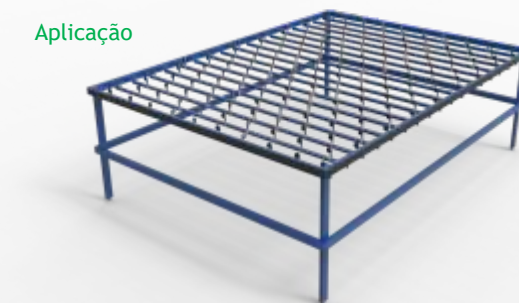

Ref.: 1530-A-FC
Espelho para fechadura de box (1529-FC) vidro / pedra

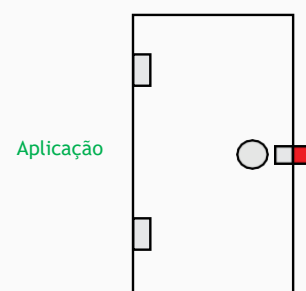

Ref.: 1001

Botão de correção com calota para vidro

Obs:



Aplicação

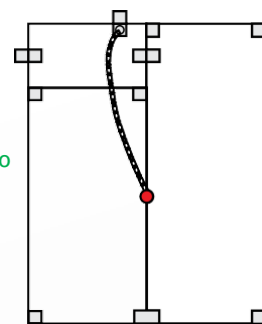

Recorte

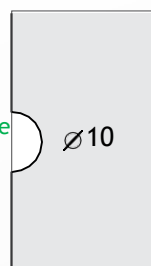

Ref.: 1002

Botão de correção simples (parafuso)

Obs:



Aplicação

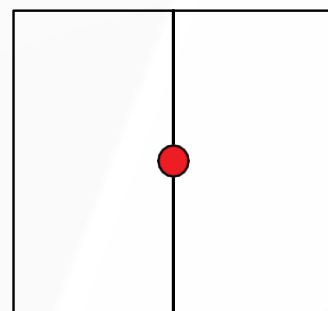

Recorte

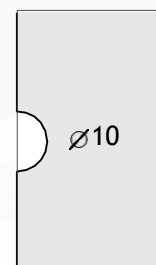

Ref.: 1002-A

Botão de correção (lâmina)



Aplicação

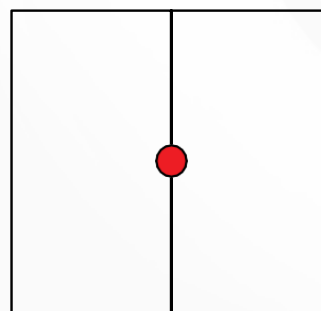

Ref.: 1002-B

Botão de correção (lâmina com calota)



Aplicação

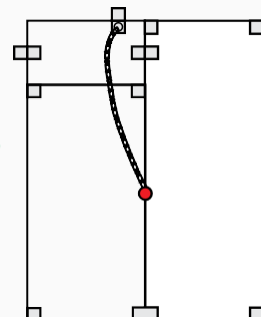

Ref.: 1003

Corrente para trinco basculante (por metro)

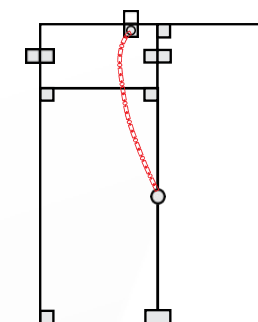

Ref.: 1003-A

Argola para corrente

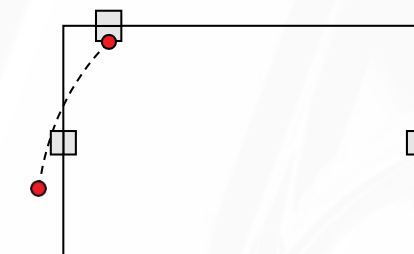

Ref.: 1005

Calota para corrente

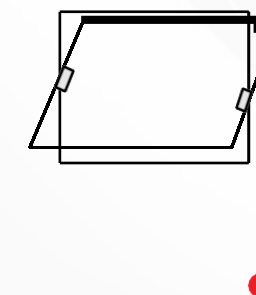

Ref.: 1009

Pivô para vidro pivotante superior e inferior

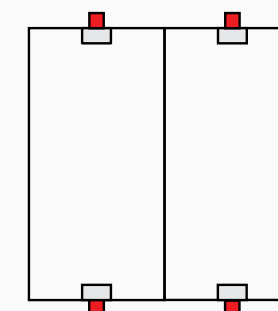

Ref.: 1013
Pivô para dobradiça inferior

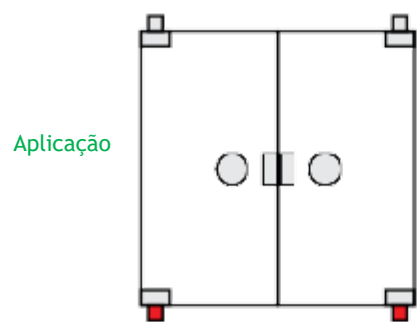

Ref.: 1014
Pivô para dobradiça excêntrica inferior

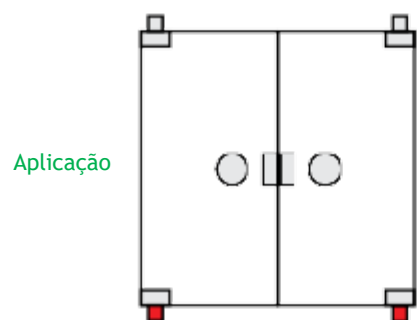

Ref.: 1038
Contra-trinco de piso

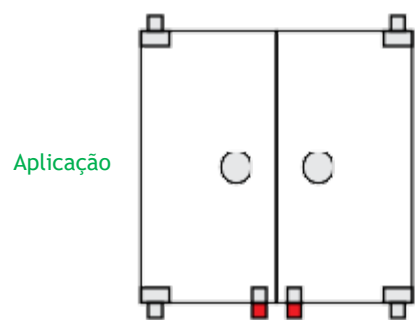

Ref.: 1038 C
Contra-trinco (capuchinho)

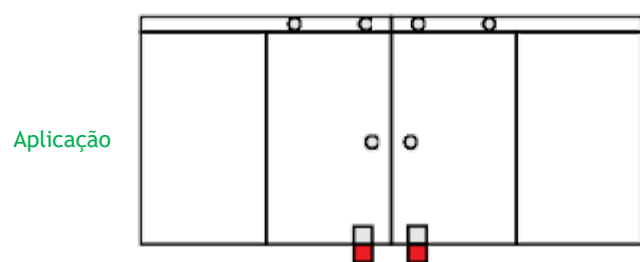

Ref.: 1101
Dobradiça superior

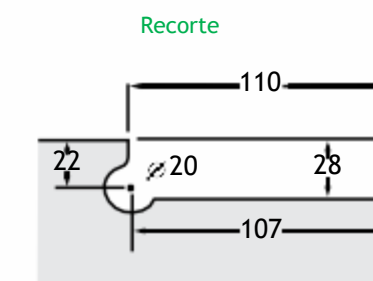
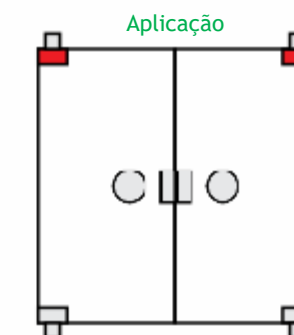

Ref.: 1103
Dobradiça inferior

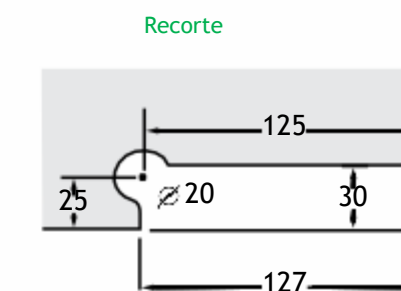
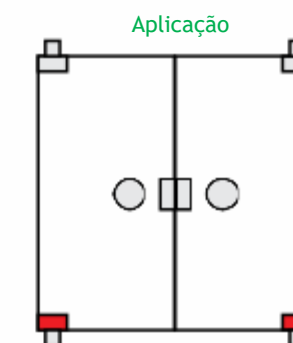

Ref.: 1104
Dobradiça direita superior excêntrica

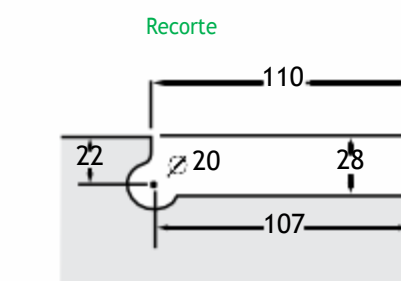
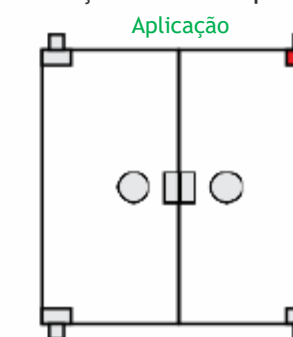

Ref.: 1105
Dobradiça esquerda superior excêntrica

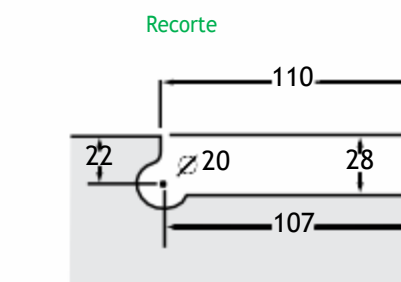
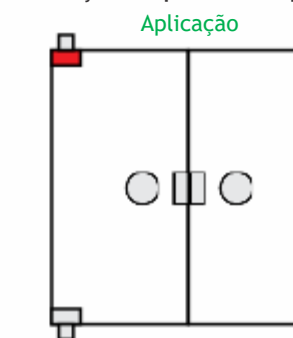

Ref.: 1108

Dobradiça Direita inferior escêntrica

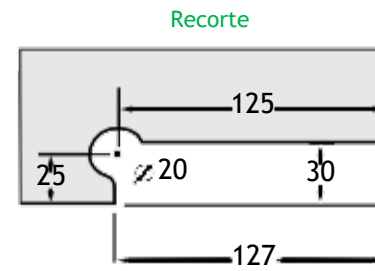
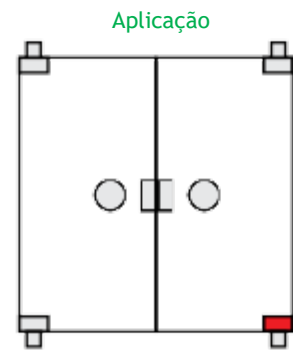

Ref.: 1109

Dobradiça esquerda inferior excêntrica

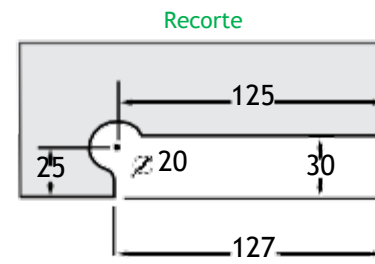
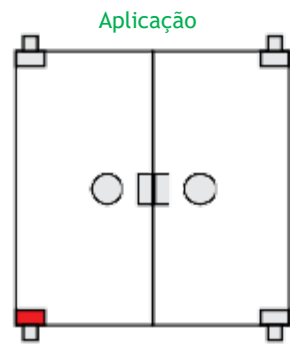

Ref.: 1110

Dobradiça pivotante superior

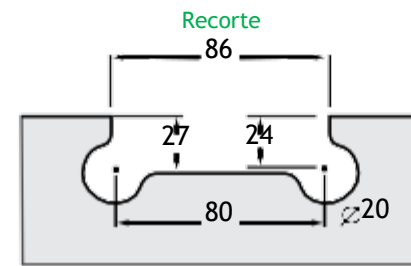
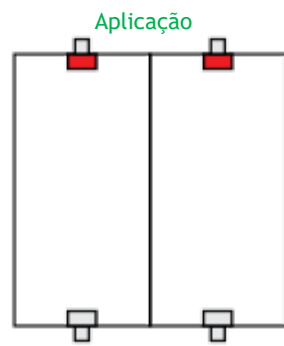

Ref.: 1112

Dobradiça pivotante inferior

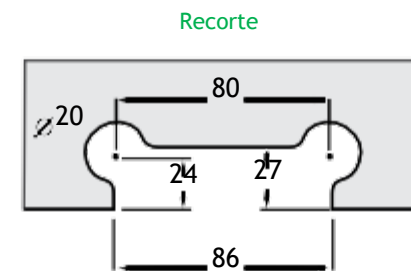
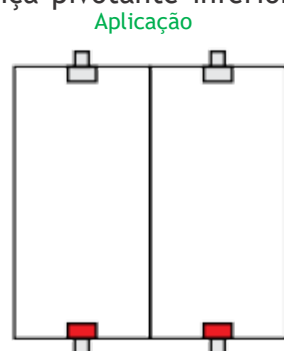

Ref.: 1113

Dobradiça pivotante inferior com trinco

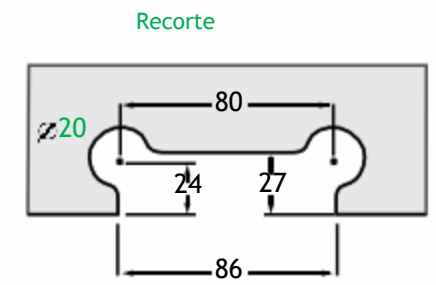
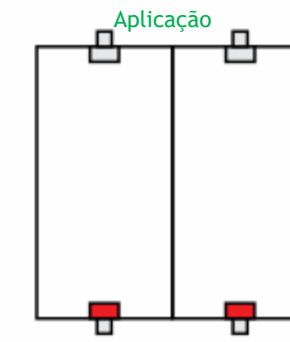

Ref.: 1114

Dobradiça automática para porta de bater

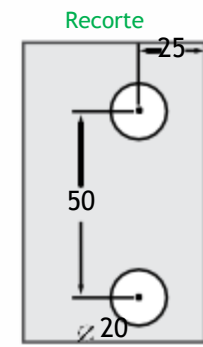
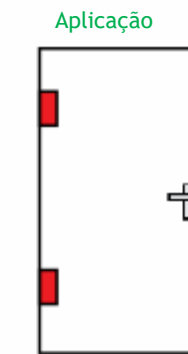

Ref.: 1114-BANG BANG

Dobradiça automática (abre para os dois lados)

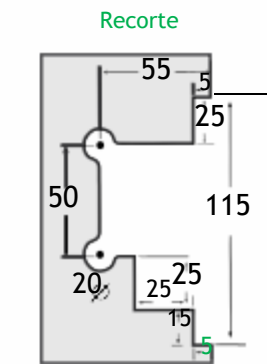
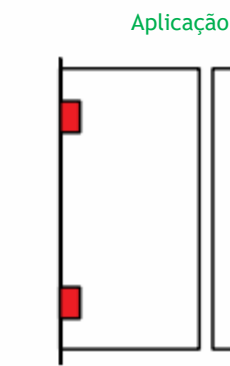

Ref.: 1115

Dobradiça lateral simples

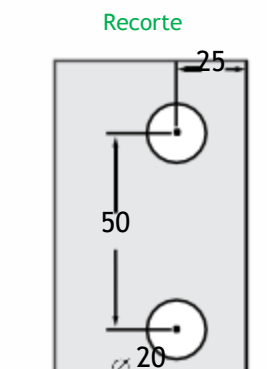
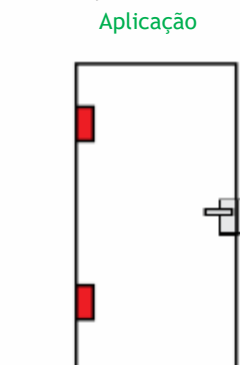

Ref.: 1116

Dobradiça lateral horizontal simples



Aplicação

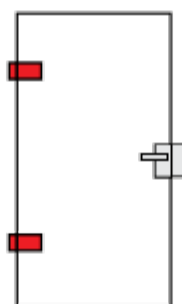

Recorte

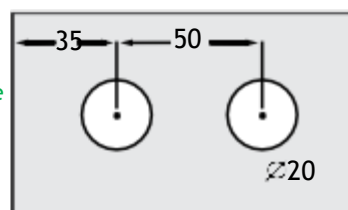

Ref.: 1123

Dobradiça para vidro basculante



Aplicação

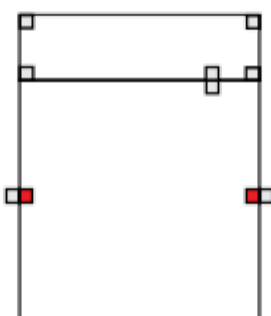

Recorte

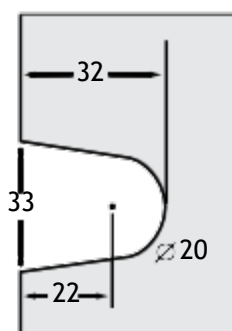

Ref.: 1123-A

Dobradiça para vidro basculante com trinco



Aplicação

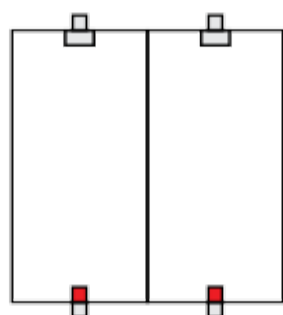

Recorte

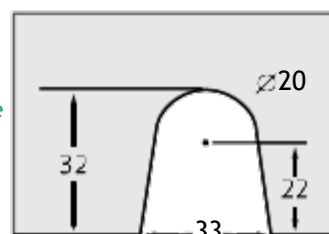

Ref.: 1123-M

Mini dobradiça para vidro basculante



Aplicação

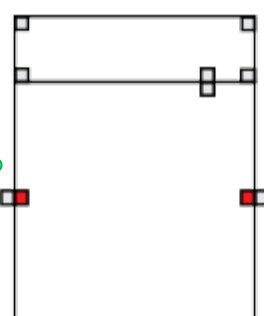

Recorte

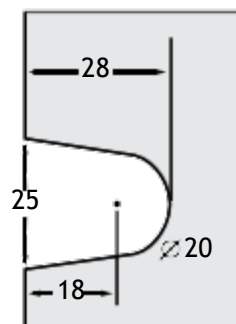

Ref.: 1123 M-A

Mini dobradiça para vidro basculante com trinco

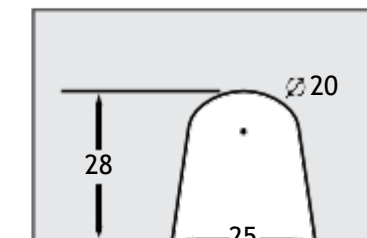
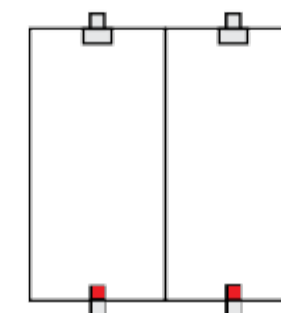

Ref.: 1124

Suporte superior com roldana para porta sanfonada

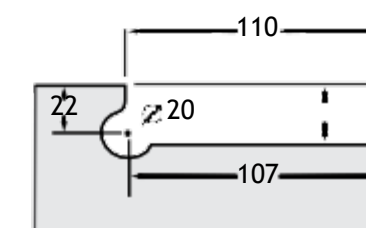
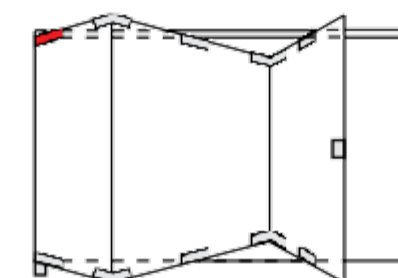

Ref.: 1126

Carrinho para porta de correr

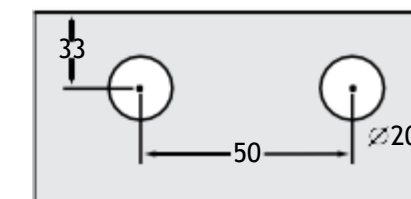
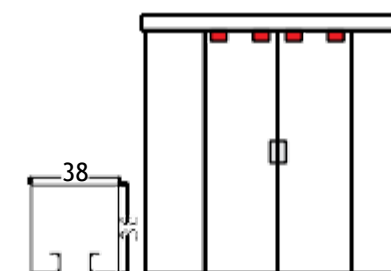

Ref.: 1126-C

Carrinho para porta de correr com roldana côncava

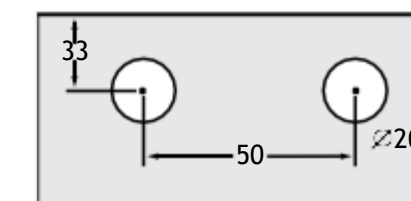
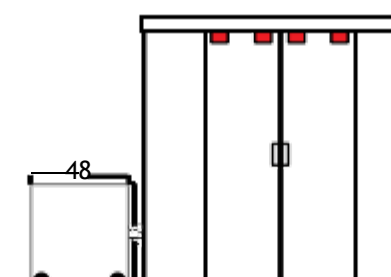

Ref.: 1126 MC

Mini carrinho para porta de correr com roldana côncava



Aplicação

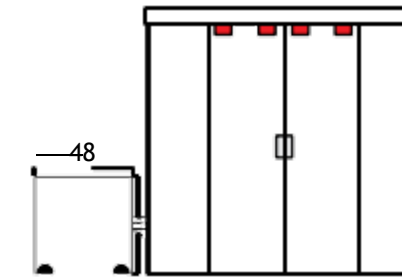

Recorte

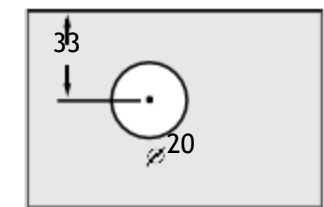

Ref.: 1126-D

Carrinho duplo para porta correr



Aplicação

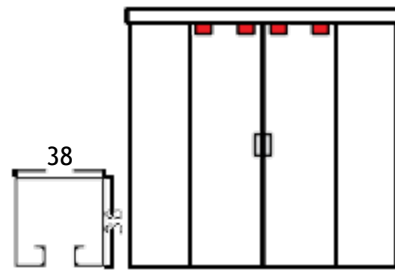

Recorte

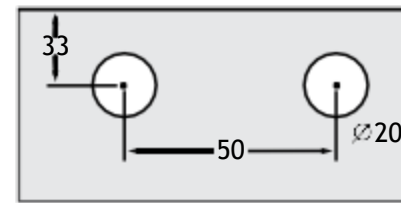

Ref.: 1127

Suporte central com roldana chanfrada para porta sanfonada



Aplicação

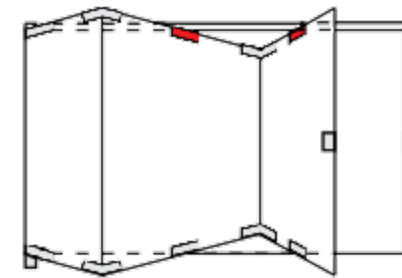

Recorte

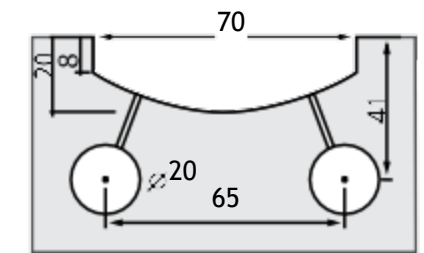

Ref.: 1126-DC

Carrinho duplo para porta correr com roldana côncava



Aplicação

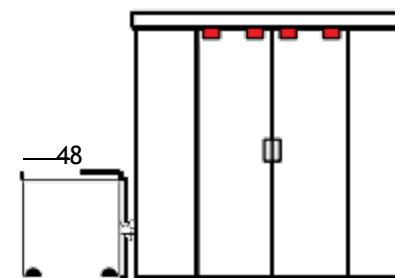

Recorte

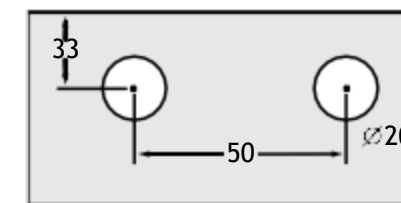

Ref.: 1127-A

Suporte inferior com pino para porta sanfonada



Aplicação

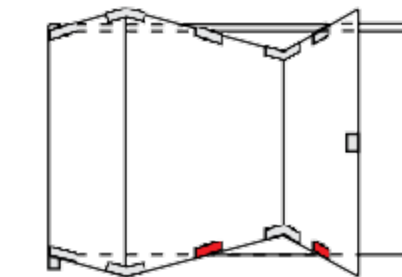

Recorte

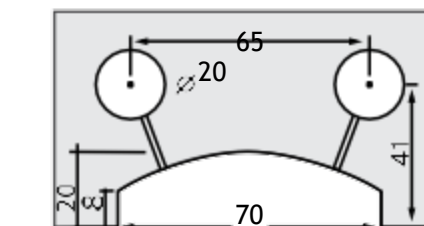

Ref.: 1126-M

Mini carrinho para porta e correr



Aplicação

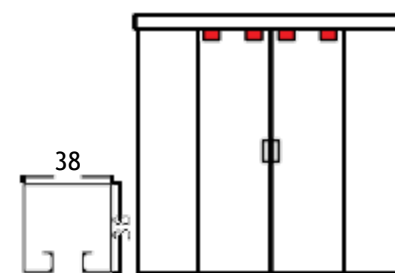

Recorte

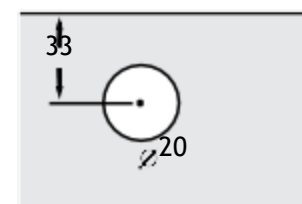

Ref.: 1128-A

Dobradiça Horizontal lateral com ponto de giro de 65mm



Aplicação

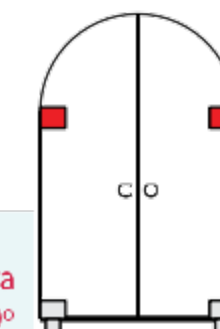

Recorte

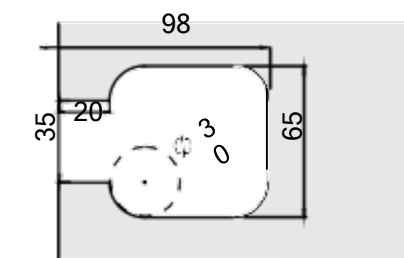

Obs:
Limitar abertura
da porta em 90°



Ref.: 1128-B
Dobradiça horizontal de canto com ponto de giro a 65mm

Aplicação

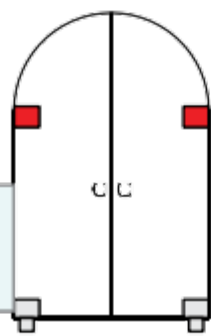

Recorte

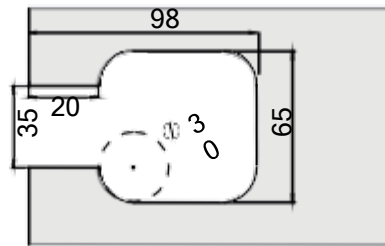

Obs:
Limitar abertura da porta em 90°



Ref.: 1129-D-ÂNG
Dobradiça DIREITA dupla automática vidro/vidro para ângulo

Aplicação

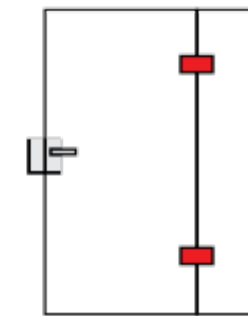

Recorte

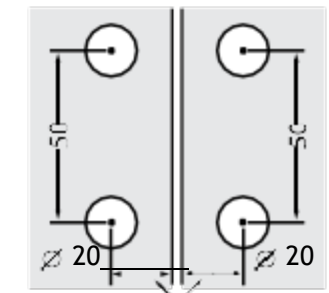

Em 90° = 45 porta e 55 fixo / 180° = 28 porta e fixo



Ref.: 1128-C
Dobradiça horizontal vidro/vidro com ponto de giro de 65mm

Aplicação

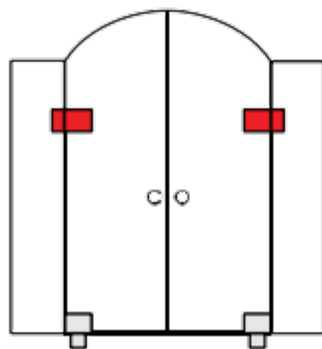

Recorte

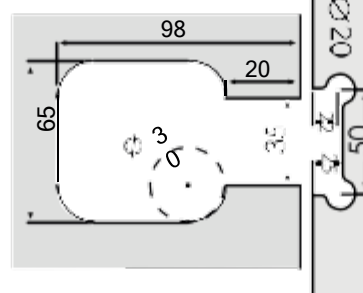

Obs:
Limitar abertura da porta em 90°



Ref.: 1129-E-ÂNG
Dobradiça ESQUERDA dupla automática vidro/vidro para ângulo

Aplicação

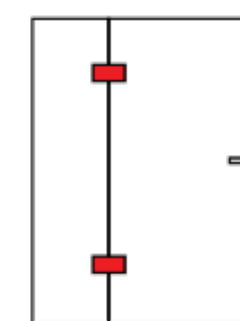

Recorte

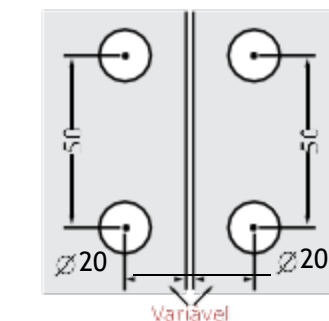

Em 90° = 45 porta e 55 fixo / 180° = 28 porta e fixo



Ref.: 1129-D
Dobradiça DIREITA dupla automática vidro/vidro

Aplicação

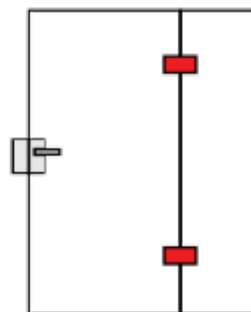

Recorte

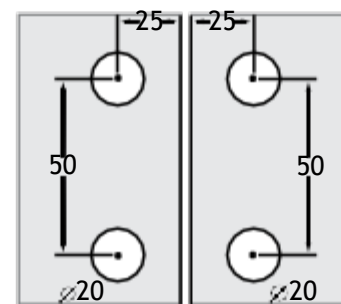

Ref.: 1130
Suporte para basculante e pivotante com pino

Aplicação

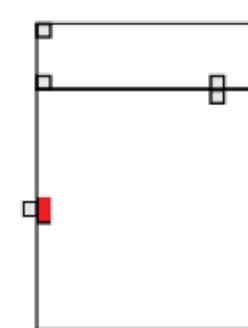

Recorte

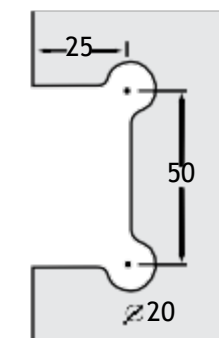

Ref.: 1129-E
Dobradiça ESQUERDA dupla automática vidro/vidro

Aplicação

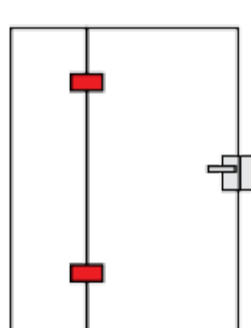

Recorte

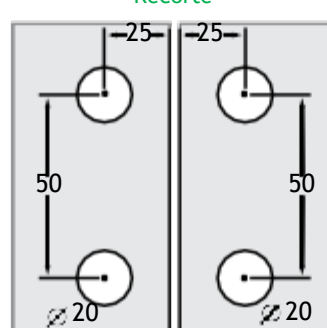

Ref.: 1131
Dobradiça para porta de bater com ponto de giro deslocado a 30mm

Aplicação

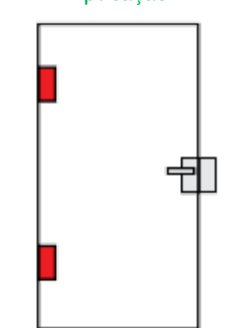

Recorte

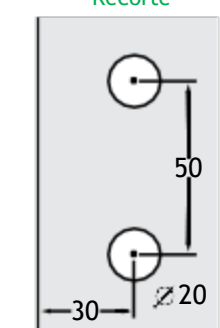

Ref.: 1132

Dobradiça horizontal dupla superior

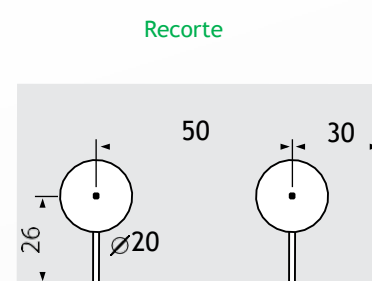
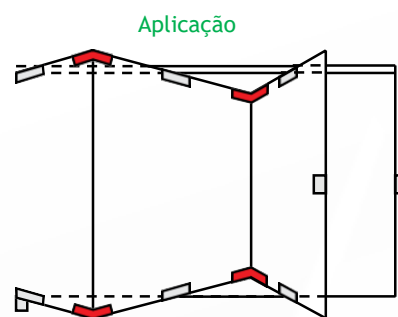

Ref.: 1132-A

Dobradiça horizontal dupla com trinco à esquerda

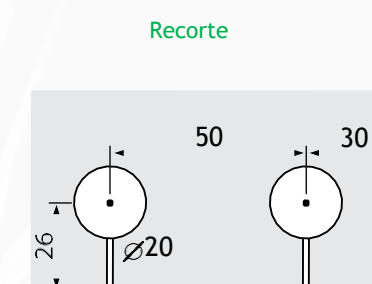
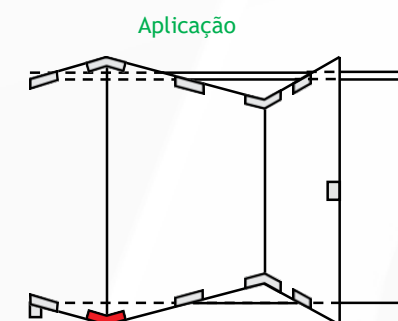

Ref.: 1132-B

Dobradiça Horizontal dupla com trinco à direita Interna

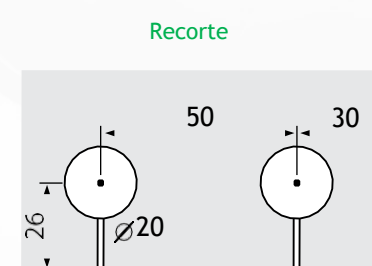
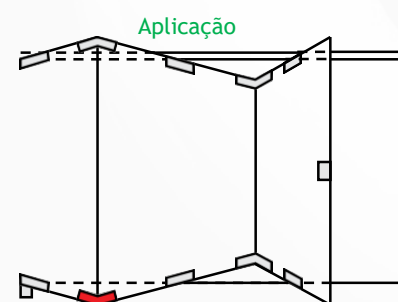

Ref.: 1132-C

Dobradiça Horizontal dupla com trinco a direita externa

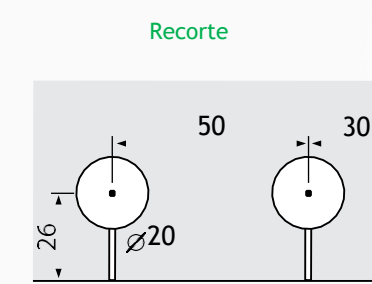
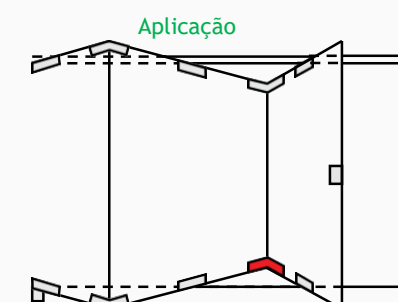

Ref.: 1132-D

Dobradiça horizontal dupla com trinco à esquerda externa

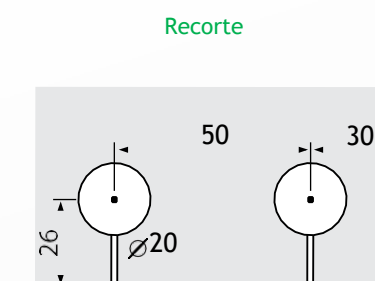
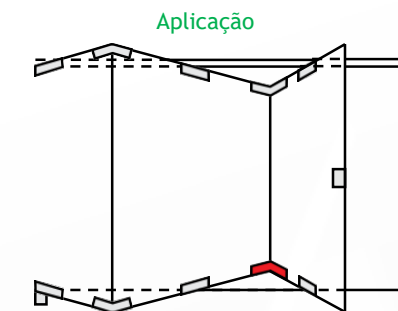

Ref.: 1136

Dobradiça lateral horizontal com giro deslocado a 25mm

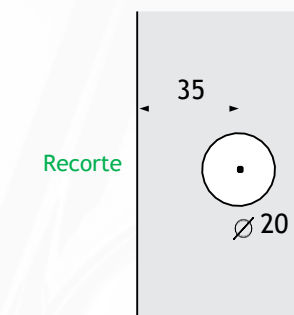
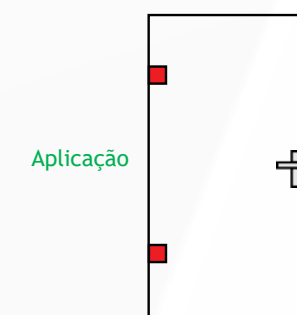

Ref.: 1136-M

Mini dobradiça lateral horizontal

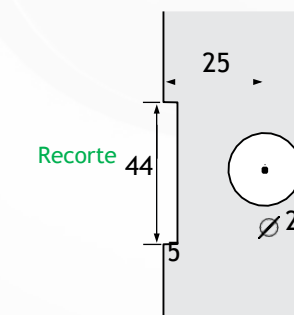
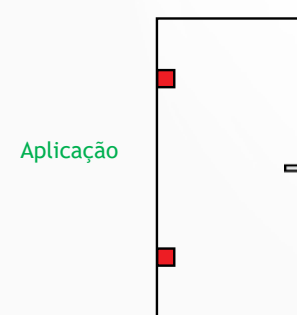

Ref.: 1137

Dobradiça horizontal dupla com giro deslocado a 25mm

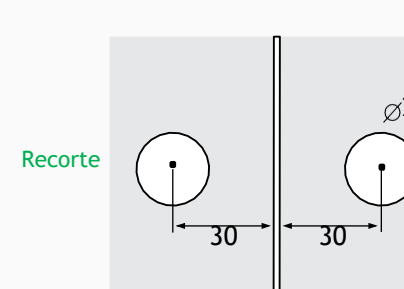
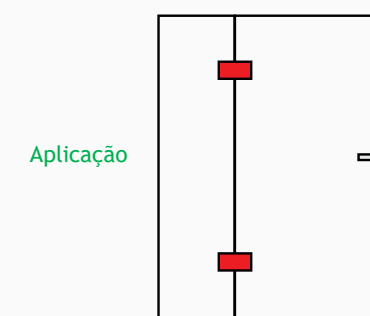

Ref.: 1137-M

Mini dobradiça horizontal dupla



Aplicação

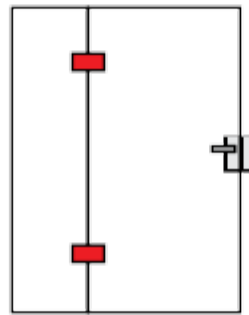

Recorte

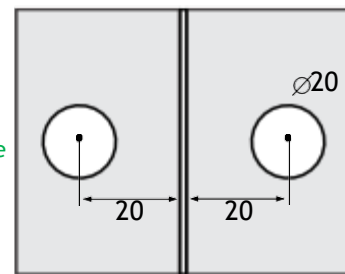

Ref.: 1206

Suporte DIREITO para bandeira com ponto de giro excêntrico



Aplicação

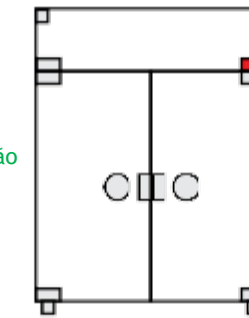

Recorte

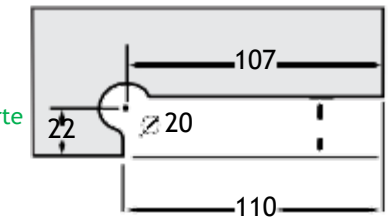

Ref.: 1201

Bucha para pivô de dobradiça



Aplicação

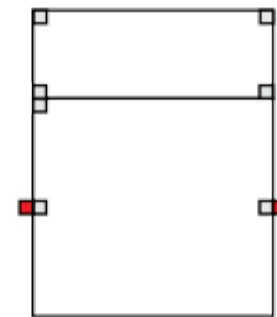

Ref.: 1207

Suporte ESQUERDO para bandeira com ponto de giro excêntrico



Aplicação

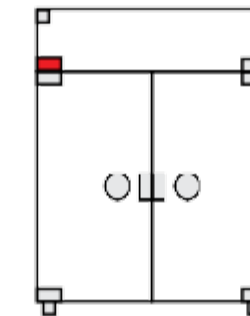

Recorte

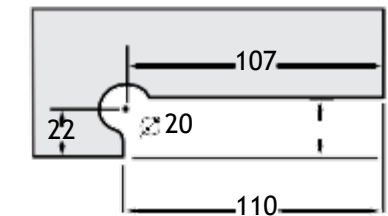

Ref.: 1202

Suporte simples com ponto de giro para dobradiça superior



Aplicação

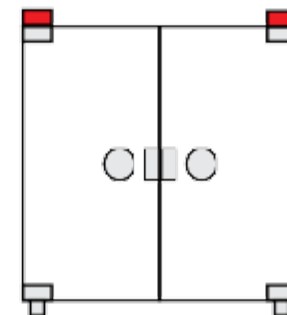

Ref.: 1209

Facão simples para lateral e bandeira



Aplicação

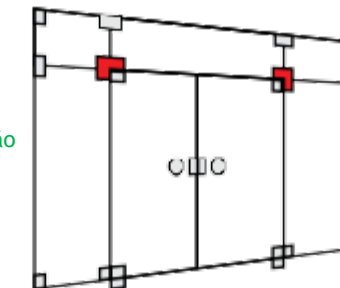

Recorte

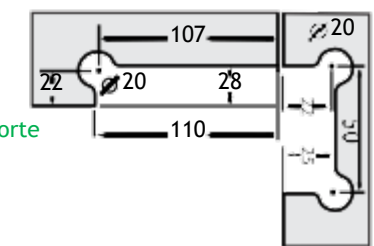

Ref.: 1203

Suporte para bandeira com ponto de giro para dobradiça superior



Aplicação

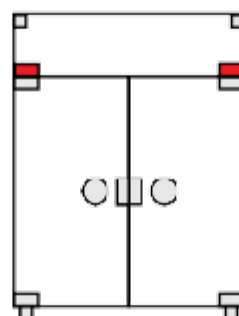

Recorte

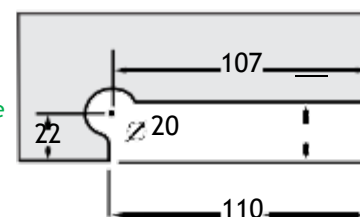

Ref.: 1209-D-90

Facão direito com ângulo de 90°



Aplicação

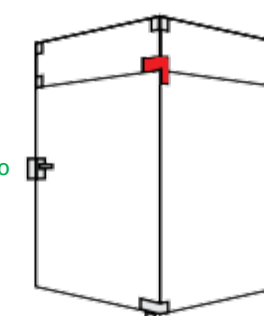

Colante
Recorte

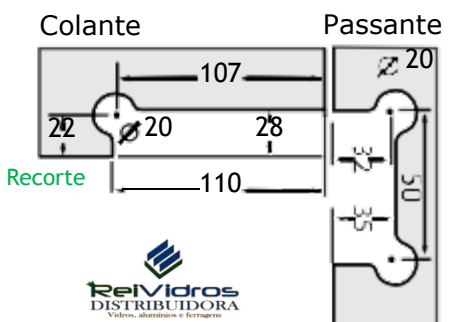

Ref.: 1209-E-90

Facão Esquerdo com ângulo de 90°



Aplicação
Vista

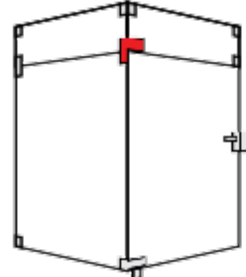

Recorte

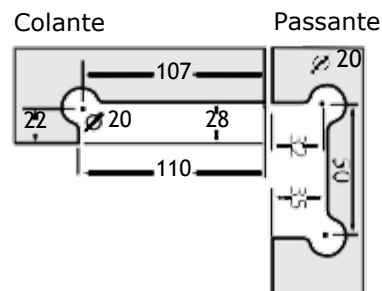

Aplicação

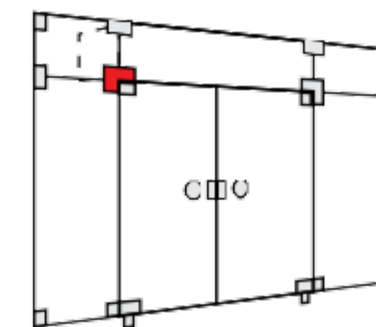

Recorte

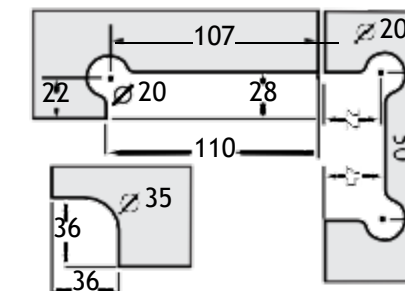

Ref.: 1209-D135°

Facão Direito com ângulo de 135°



Aplicação

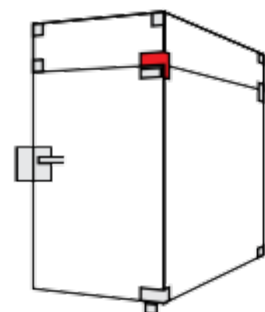

Recorte

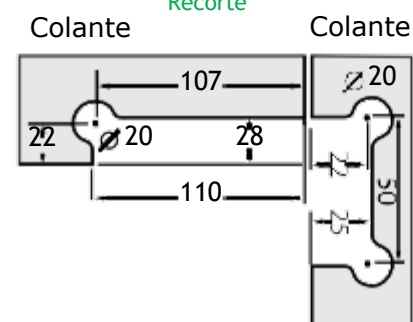

Aplicação

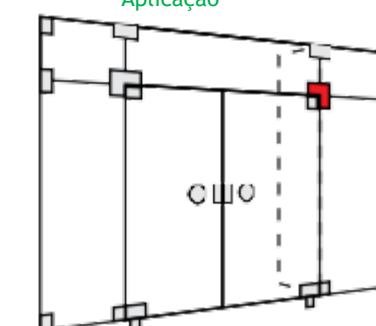

Recorte

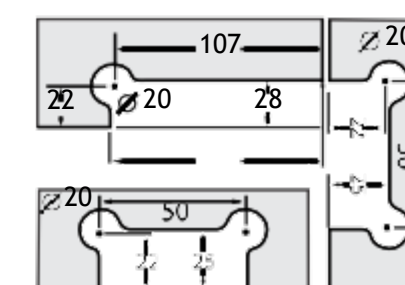

Ref.: 1209-E-135

Facão Esquerdo com ângulo de 135°



Aplicação

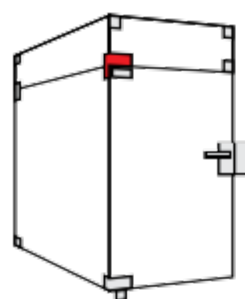

Recorte

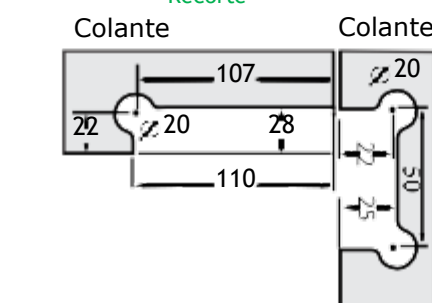

Aplicação

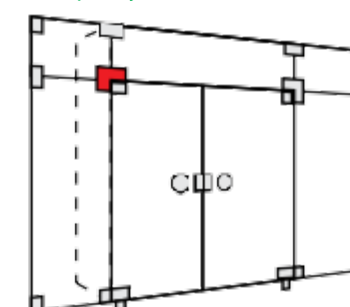

Recorte

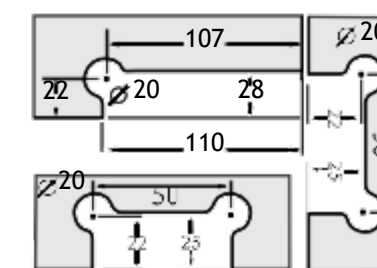

Ref.: 1218

Facão Direito lateral e bandeira e suporte para contravento



Aplicação

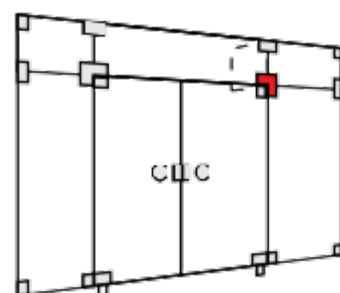

Recorte

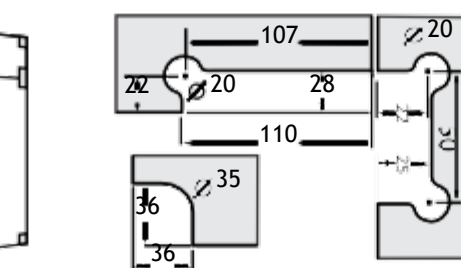

Aplicação

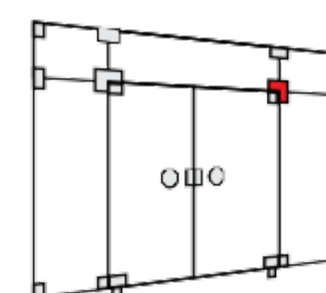

Recorte

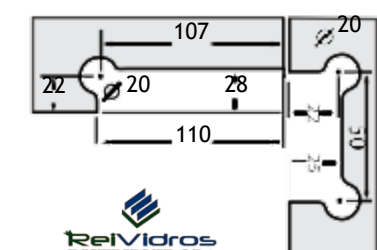

Ref.: 1211-E-90

Facão Esquerdo para lateral e bandeira e suporte para contravento

Ref.: 1229

Facão Direito para lateral e bandeira e suporte para contravento uplo

Ref.: 1213

Facão Esquerdo para lateral e bandeira e suporte para contravento duplo

Ref.: 1214

Facão Direito para lateral e bandeira com ponto giro excêntrico

Ref.: 1215

Facão Esquerdo para lateral e bandeira com ponto giro excêntrico

Aplicação
Vista externa

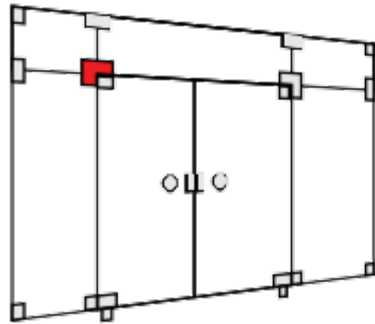

Recorte

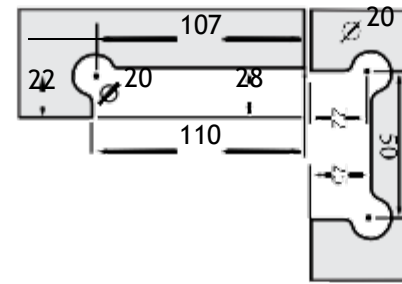

Ref.: 1216

Facão Direito para lateral e bandeira com ponto de giro excêntrico e suporte para contravento interno

Aplicação

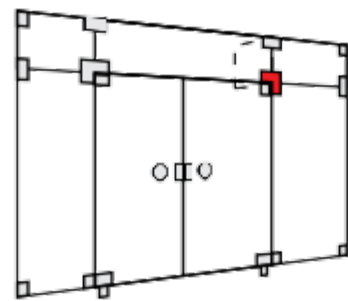
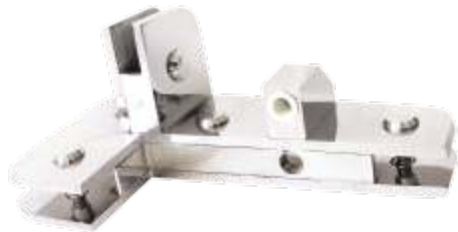

Recorte

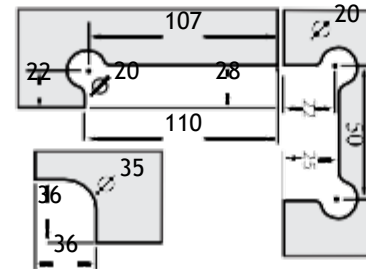

Ref.: 1217

Facão Esquerdo para lateral e bandeira com ponto de giro excêntrico e suporte para contravento interno

Aplicação

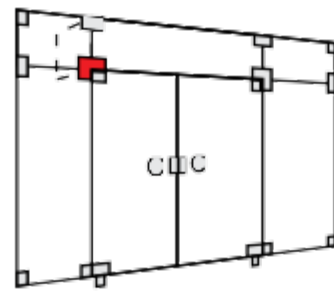

Recorte

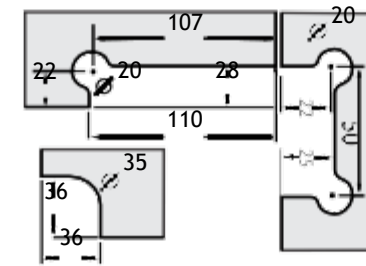

Ref.: 1210

Facão Direito lateral e bandeira e suporte para contravento

Aplicação

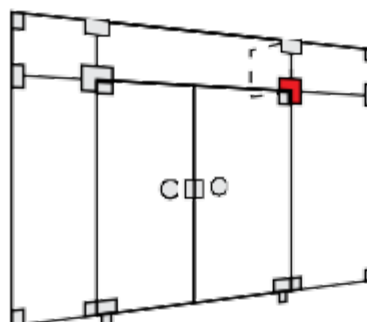

Recorte

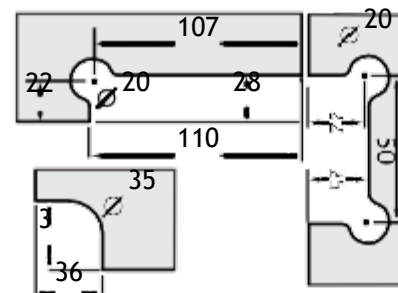

Ref.: 1219

Facão Esquerdo para lateral com ponto de giro excêntrico e suporte para contravento externo

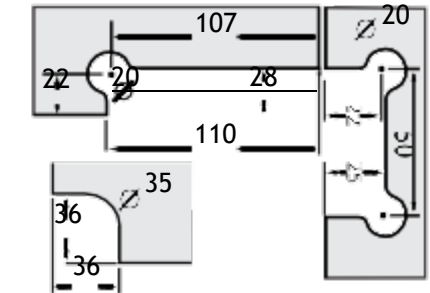
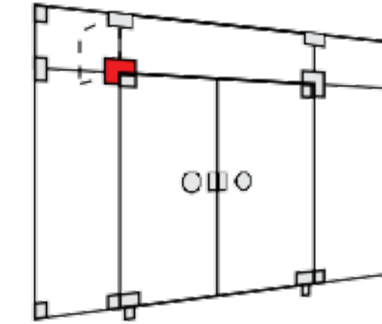

Ref.: 1229

Facão simples com ponto de giro e contravento para peças pivotantes

Aplicação

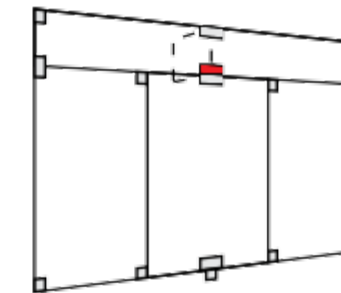

Recorte

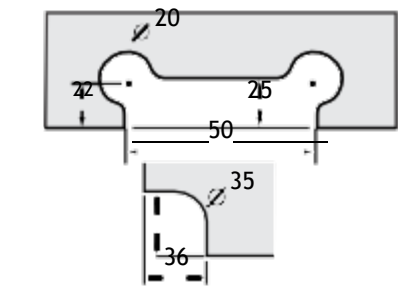

Ref.: 1230

Suporte para vidro basculante

Aplicação

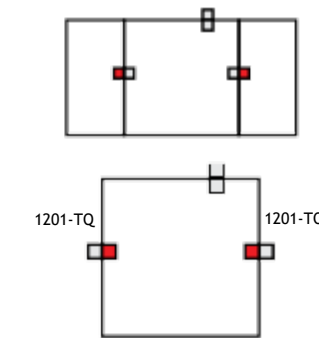

Recorte

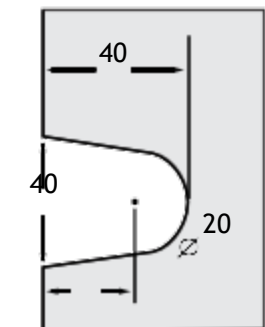

Ref.: 1230-M

Mini Suporte para basculante

Aplicação

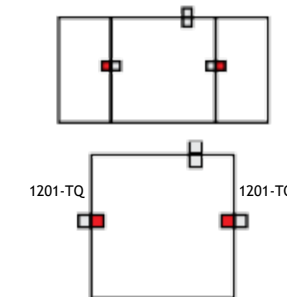

Recorte

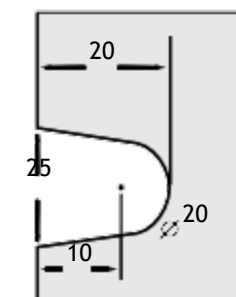



Ref.: 1231

Suporte com ponto de giro para vidro basculante e pivotante

Aplicação

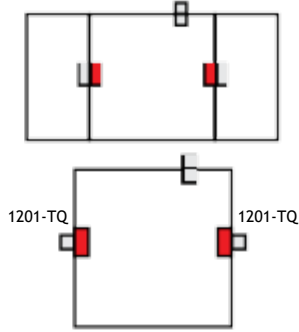

Recorte

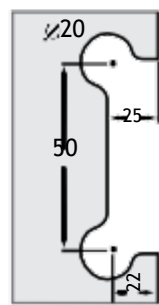

Ref.: 1304

Suporte sem miolo para união de dois vidros

Aplicação

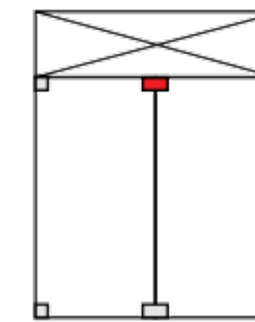

Recorte

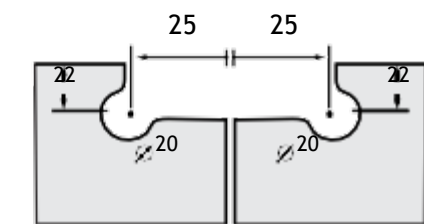

Ref.: 1301

Facão Direito para bandeira com ponto de giro, batente e suporte para contravento

Aplicação

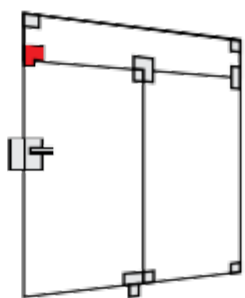

Recorte

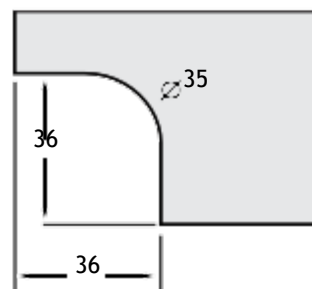

Ref.: 1305

Suporte sem miolo para união de dois vidros intermediários

Aplicação

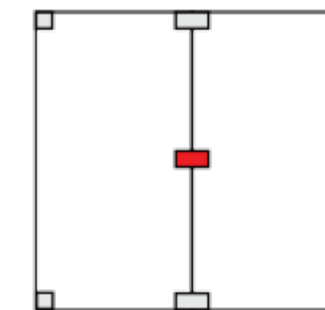

Recorte

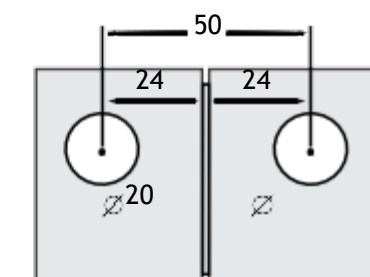

Ref.: 1302

Suporte de canto

Aplicação

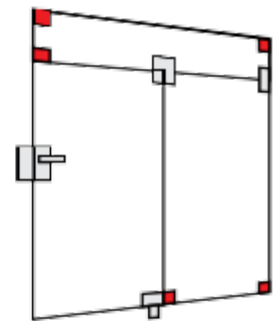

Recorte

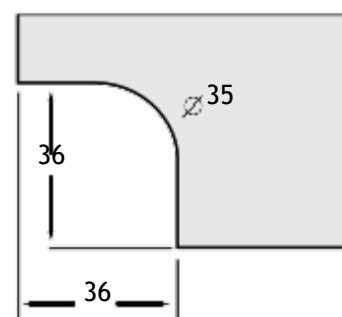

Ref.: 1306

Suporte com miolo para união de dois vidros

Aplicação

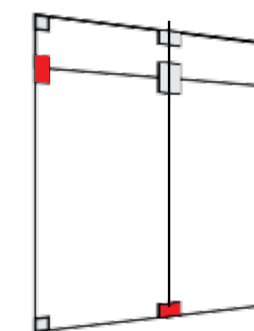

Recorte

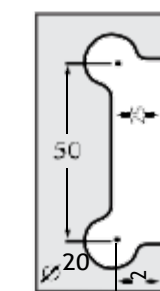

Ref.: 1303

Suporte de canto com contravento

Aplicação

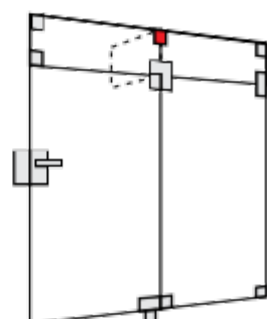

Recorte

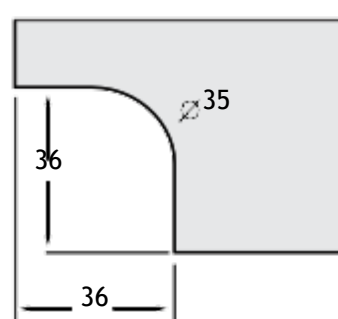

Ref.: 1307

Suporte sem miolo para união de três vidros em "T"

Aplicação

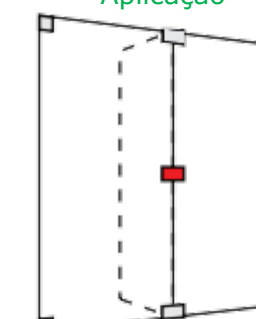

Recorte

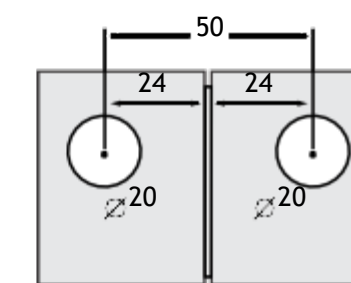

Ref.: 1308
Suporte com miolo para união de três vidros em "T"



Aplicação

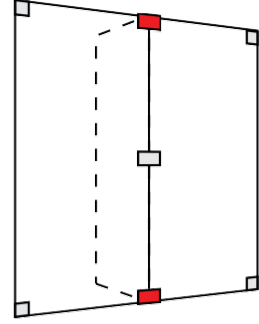

Recorte

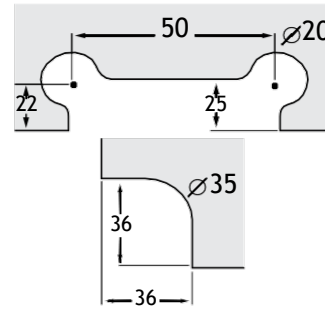

Ref.: 1311
Suporte para união de dois ou três vidros em "L" e contravento simples à DIREITA



Aplicação

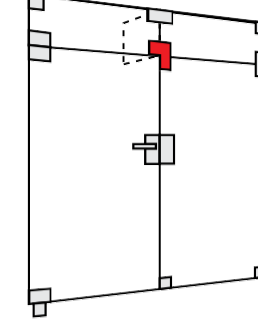

Recorte

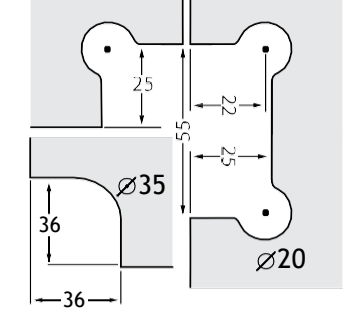

Ref.: 1309
Suporte sem miolo para união de três vidros em "T"



Aplicação

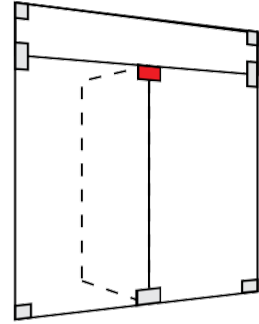

Recorte

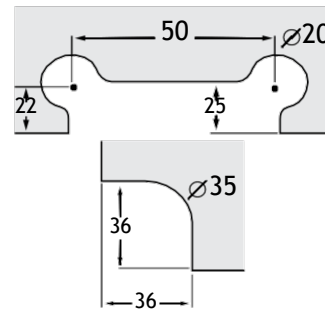

Ref.: 1311-A
Suporte para união de dois ou três vidros em "L" e contravento duplo à DIREITA



Aplicação

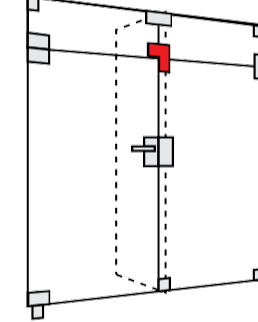

Recorte

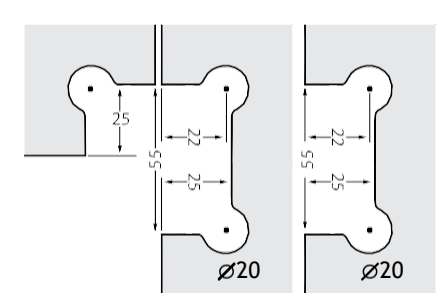

Ref.: 1310
Suporte para união de dois ou três vidros em "L"



Aplicação

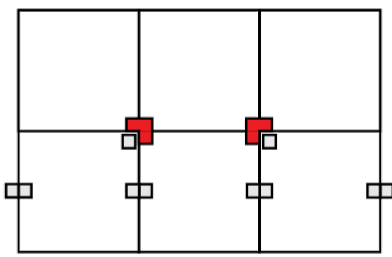

Recorte

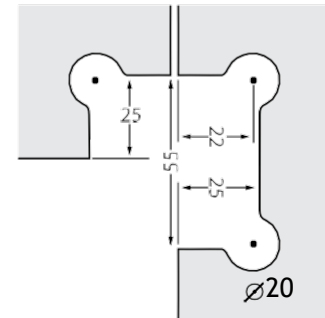

Ref.: 1310-A
Suporte DIREITO para união de dois ou três vidros em "L" com batente e contra trinco



Aplicação

Vista interna

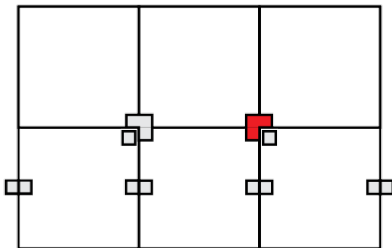

Recorte

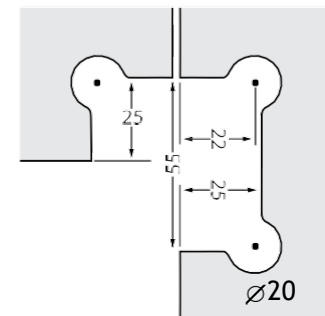

Ref.: 1311-B
Suporte para união de dois ou três vidros em "L" e contravento simples à DIREITA



Aplicação

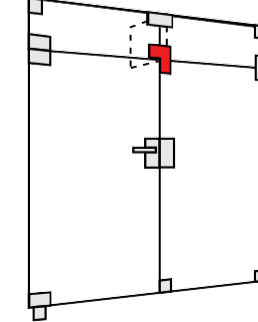

Recorte

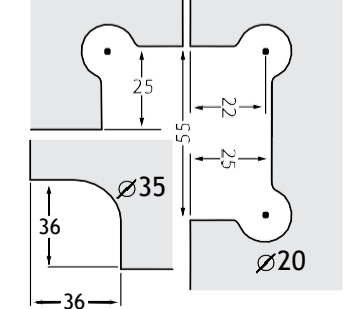

Ref.: 1312

Suporte para união de dois ou três vidros em "L" e contravento simples à ESQUERDA

Aplicação

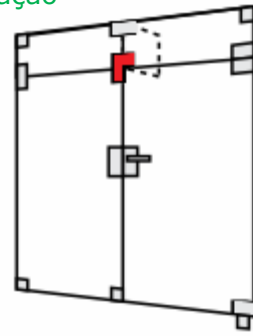

Recorte

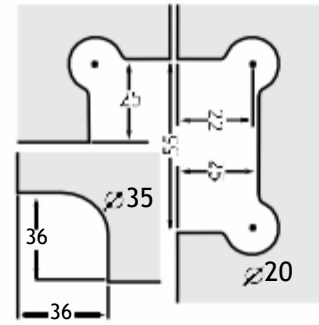

Ref.: 1312-A

Suporte para união de dois ou três vidros em "L" e contravento duplo à ESQUERDA

Aplicação

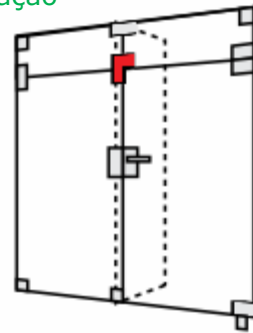

Recorte

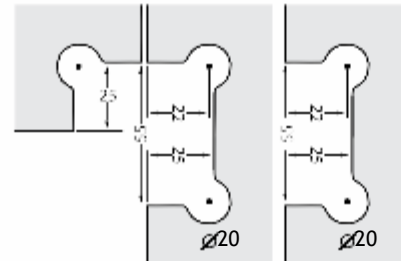

Ref.: 1312-B

Suporte para união de dois ou três vidros em "L" e contravento simples à ESQUERDA

Aplicação

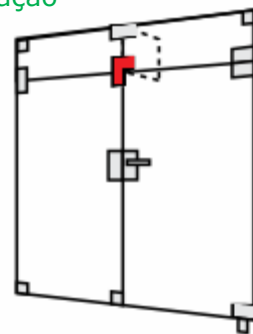

Recorte

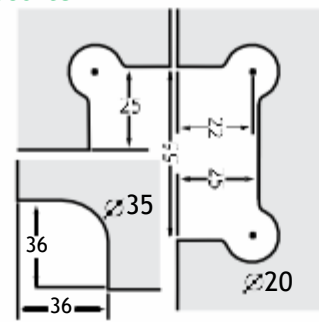

Ref.: 1313

Suporte para união de dois ou três vidros em "L" e contravento simples à DIREITA e batente

Aplicação

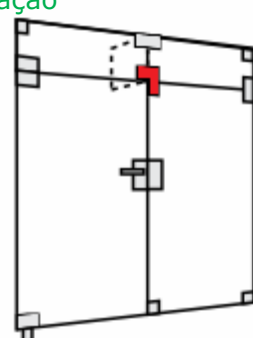

Recorte

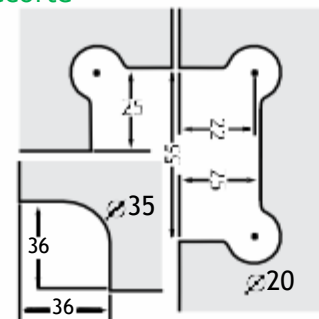

Ref.: 1313-A

Suporte para união de dois ou três vidros em "L" com contravento duplo à DIREITA e batente

Aplicação

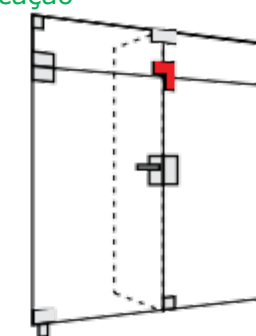

Recorte

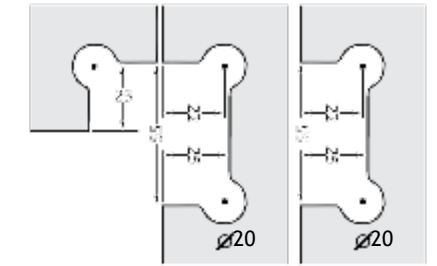

Ref.: 1314

Suporte para união de dois ou três vidros em "L" com contravento simples ESQUERDO e batente

Aplicação

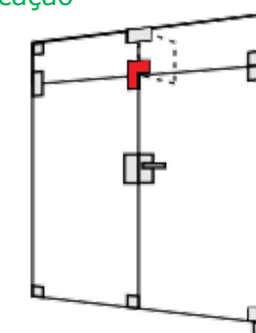

Recorte

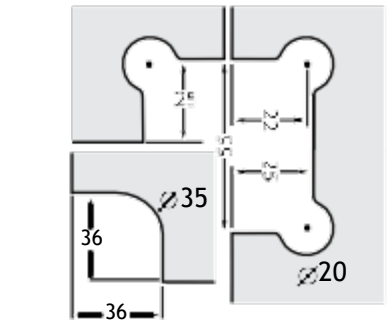

Ref.: 1314-A

Suporte para união de dois ou três vidros em "L" com contravento duplo ESQUERDO e batente

Aplicação

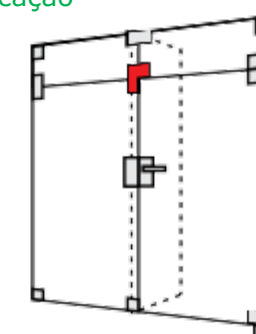

Recorte

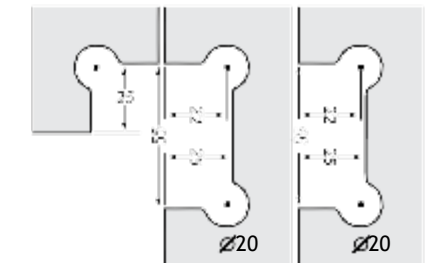

Ref.: 1315

Suporte para união de dois ou três vidros em "L" com batente

Aplicação

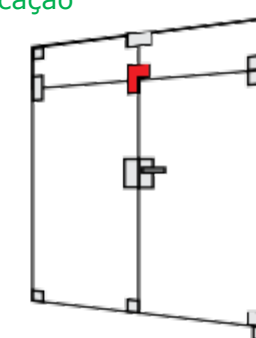

Recorte

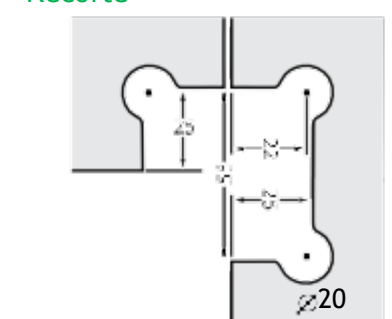

Ref.: 1316

Suporte sem miolo para união de quatro vidros



Aplicação

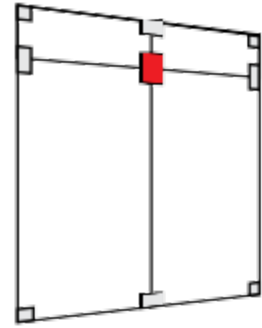

Recorte

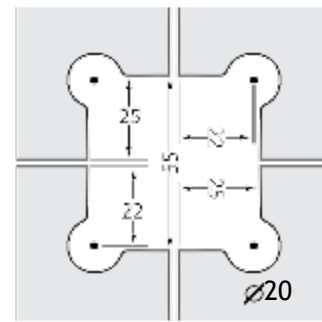

Ref.: 1319

Suporte de canto para união de quatro vidros



Aplicação

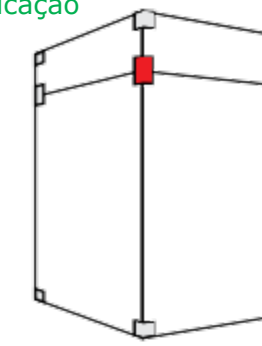

Recorte

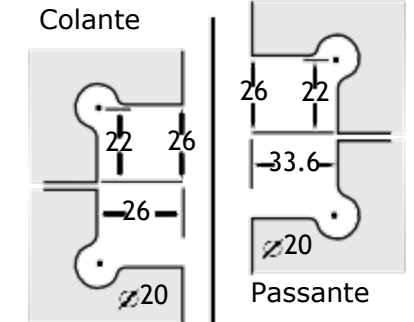

Ref.: 1317

Suporte para união de quatro vidros com suporte para contravento simples



Aplicação

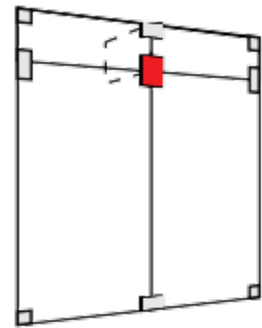

Recorte

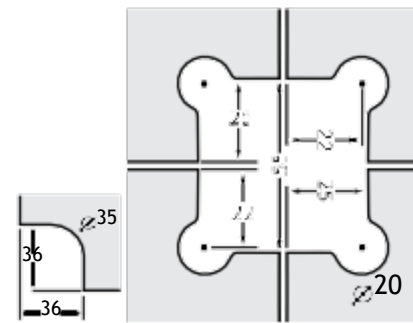

Ref.: 1320

Suporte cantoneira sem miolo



Aplicação

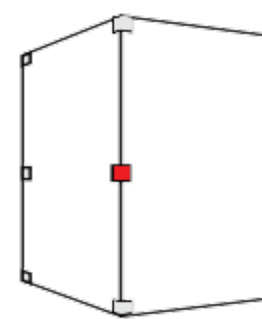

Recorte

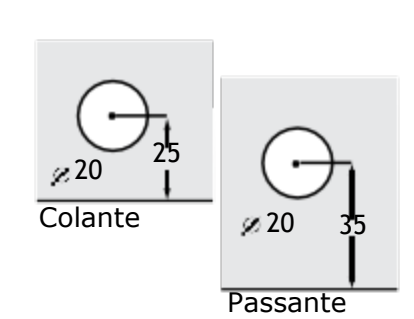

Ref.: 1318

Suporte para união de quatro vidros com suporte para contravento duplo



Aplicação

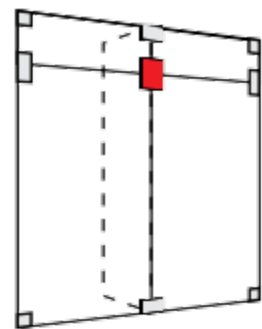

Recorte

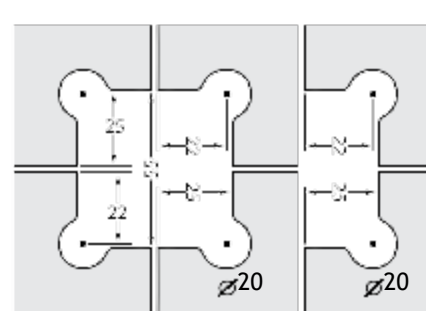

Ref.: 1320 135°

Suporte cantoneira sem miolo com ângulo de 135°



Aplicação

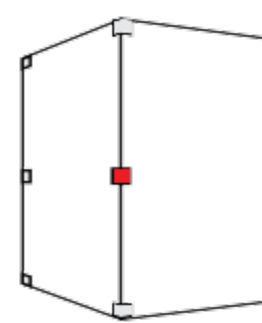

Recorte

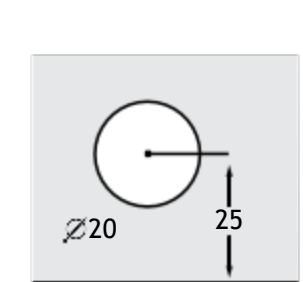

Ref.: 1318-A

Suporte para união de quatro vidros com suporte para contravento duplo deslocado



Aplicação

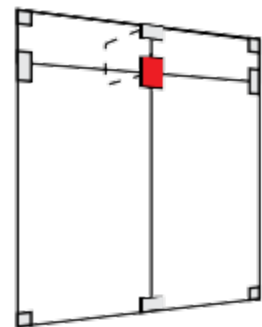

Recorte

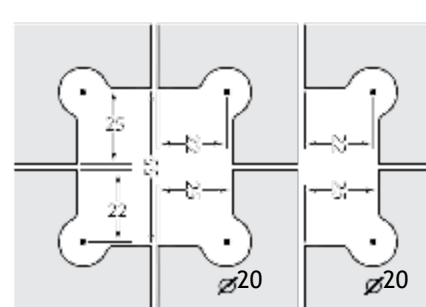

Ref.: 1321

Suporte cantoneira com miolo (inferior/superior)



Aplicação

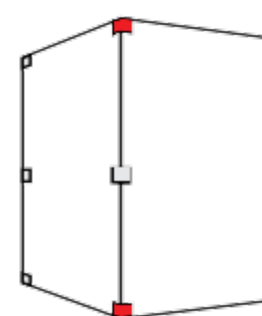

Recorte

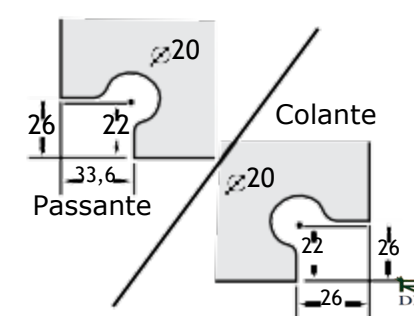

Ref.: 1321 135°

Suporte cantoneira com miolo (inferior/superior) com ângulo de 135°

Aplicação

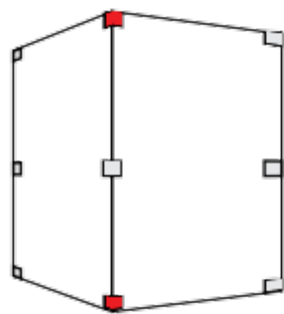

Recorte

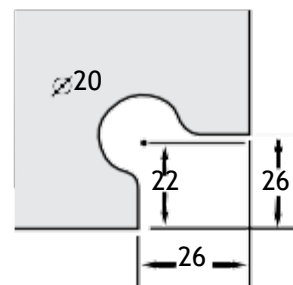

Ref.: 1326

Suporte para fixação de vidro fixo no trilho

Aplicação

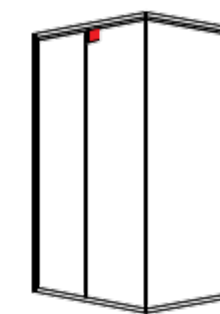

Recorte

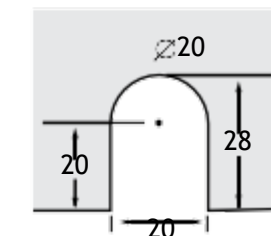

Ref.: 1322

Suporte cantoneira para união de dois vidros

Aplicação

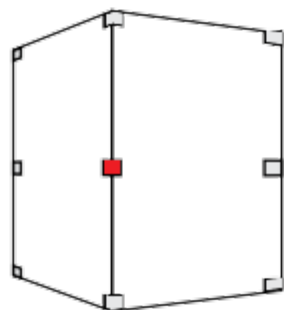

Recorte

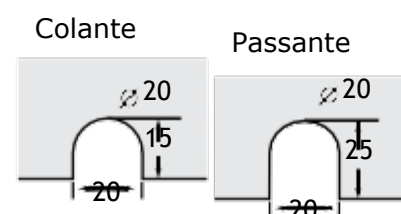

Ref.: 1329

Suporte de centro

Aplicação

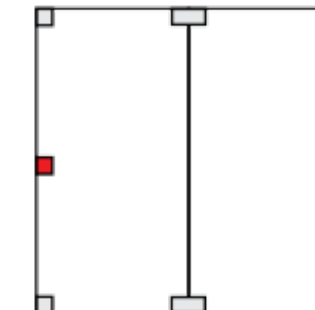

Recorte

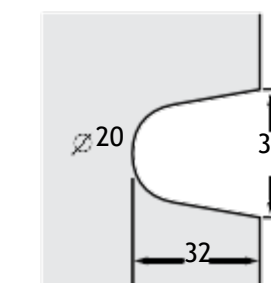

Ref.: 1322-135°

Suporte cantoneira para união de dois vidros com ângulo 135°

Aplicação

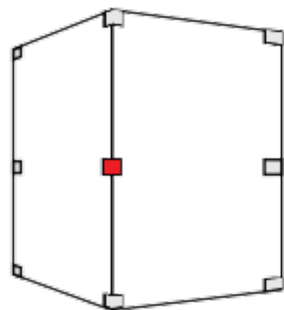

Recorte

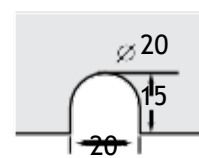

Ref.: 1333

Suporte com miolo para união de dois vidros com contravento à DIREITA

Aplicação

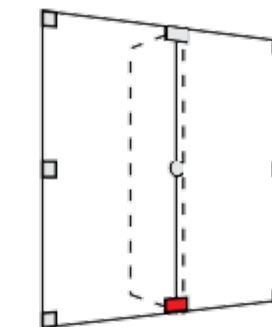
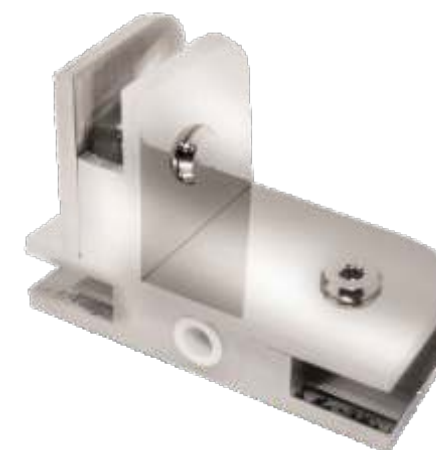

Recorte

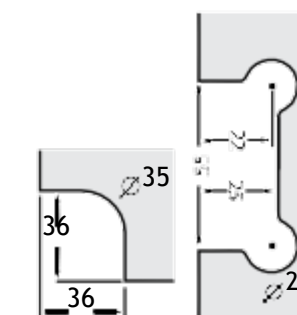

Ref.: 1323

Suporte sem miolo para união intermediária de quatro vidros

Aplicação

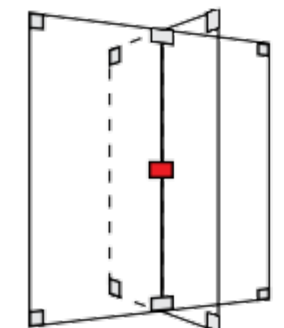

Recorte

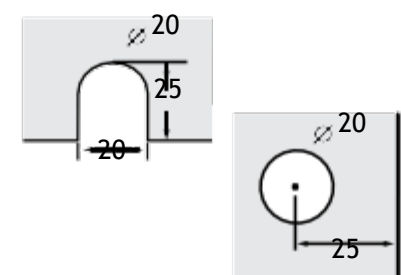

Ref.: 1334

Suporte com miolo para união de dois vidros com contravento à ESQUERDA

Aplicação

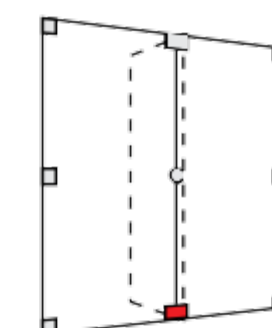

Recorte

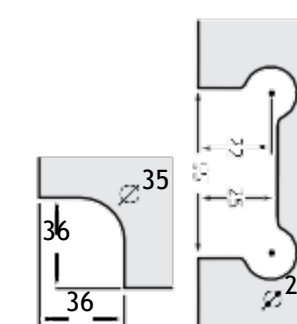

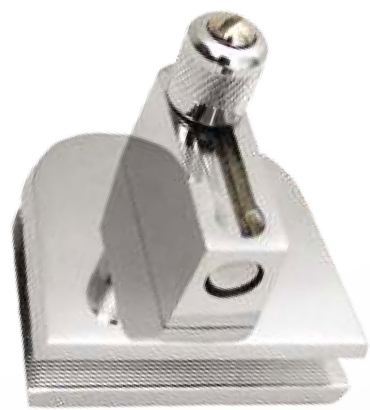

Ref.: 1335
Trinco sem miolo

Aplicação

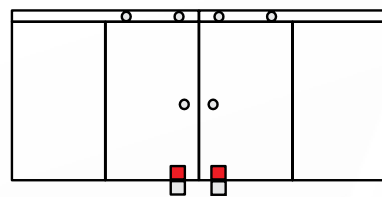

Recorte

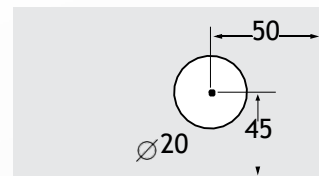

Ref.: 1335-A
Trinco com miolo

Aplicação

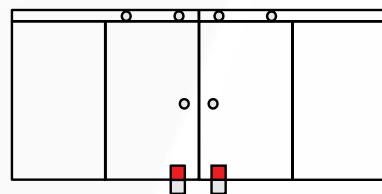

Recorte

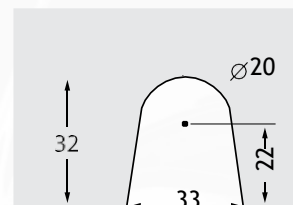

Ref.: 1335-C
Contra trinco para 1335

Aplicação

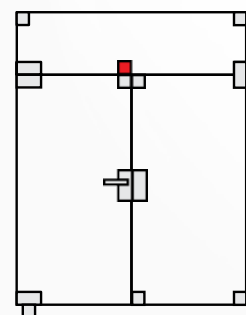

Recorte

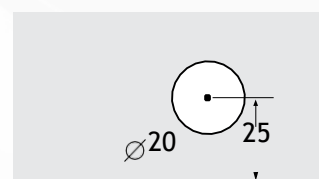

Ref.: 1335-M
Mini trinco

Aplicação

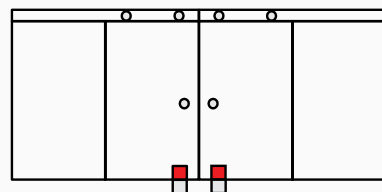

Recorte

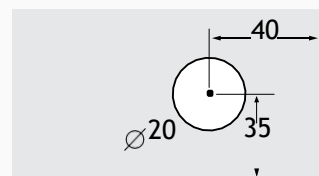

Ref.: 1336-D
Trinco de canto DIREITO

Aplicação

Vista externa

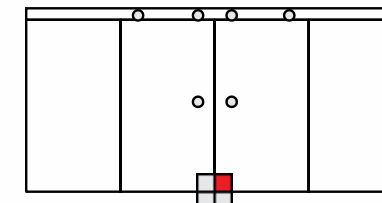

Recorte

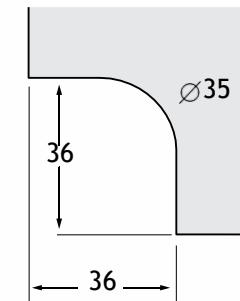

Ref.: 1336-E
Trinco de canto ESQUERDO

Aplicação

Vista externa

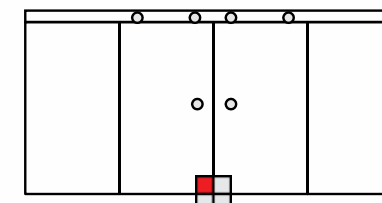

Recorte

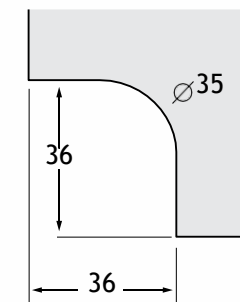

Ref.: 1401
Batente simples

Aplicação

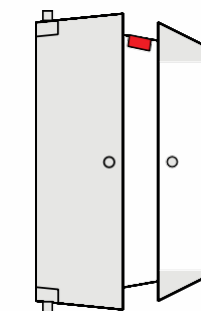

Ref.: 1402
Suporte com batente para fixação em bandeira

Aplicação

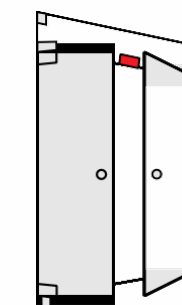

Recorte

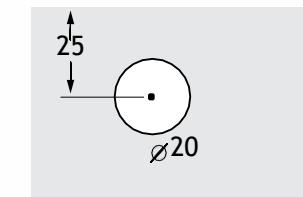

Ref.: 1502
Trinco inferior com miolo



Aplicação

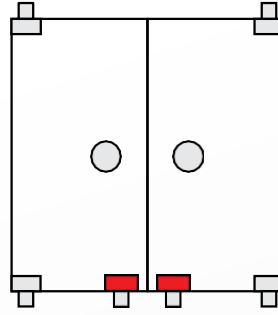

Recorte

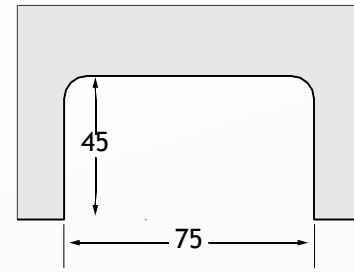

Ref.: 1504
Contra fechadura para fechadura 1520



Aplicação

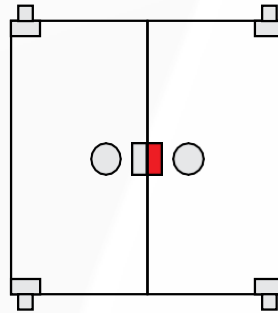

Recorte

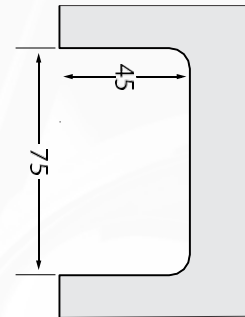

Ref.: 1504-A
Espelho com batente para fechadura 1520



Aplicação

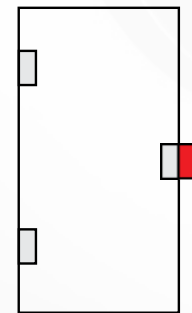

Ref.: 1505
Espelho sem batente para fechadura 1520



Aplicação

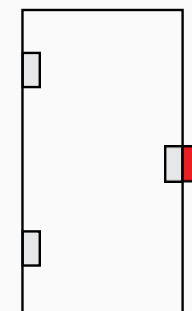

Ref.: 1510
Fechadura bico de papagaio com abas



Aplicação

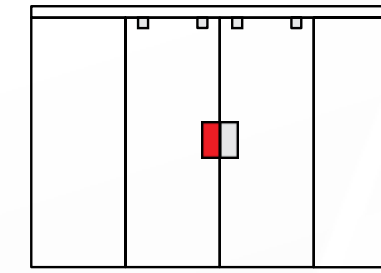

Recorte

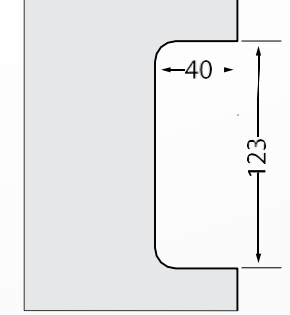

Ref.: 1510 JD
Fechadura bico de papagaio DIREITA para janela



Aplicação

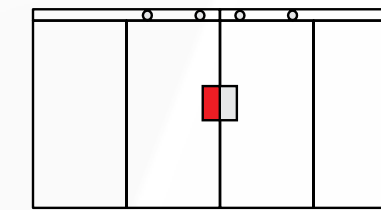

Recorte

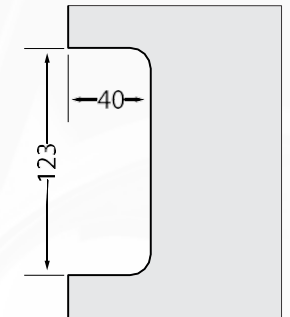

Ref.: 1510 JE
Fechadura bico de papagaio ESQUERDA para janela



Aplicação

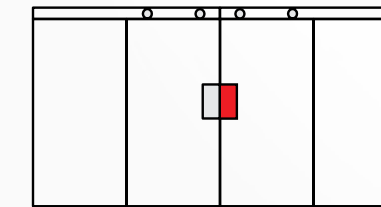

Recorte

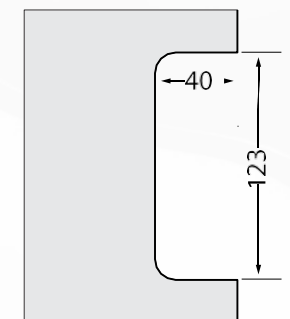

Ref.: 1511
Contra fechadura para fechadura 1510



Aplicação

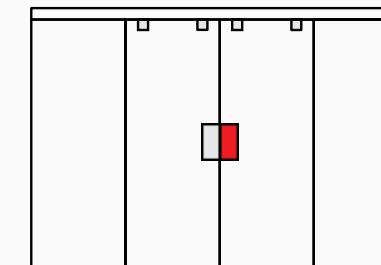

Recorte

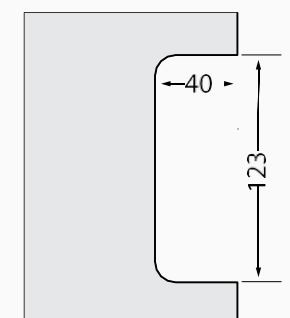



Ref.: 1511-A
Espelho para fechadura 1510 - com abas

Aplicação

Aplicação

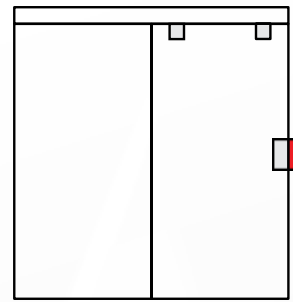

Ref.: 1511-B
Espelho para fechadura 1510 - sem abas

Aplicação

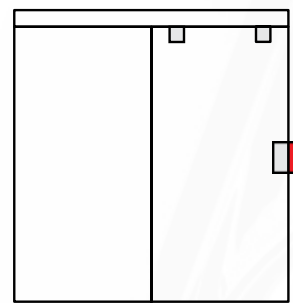

Ref.: 1511-JD
Contra fechadura para fechadura 1510 JE

Aplicação

Recorte

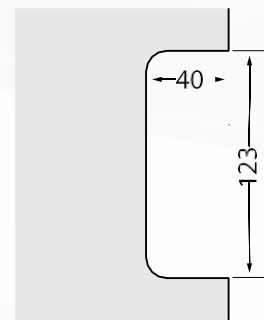
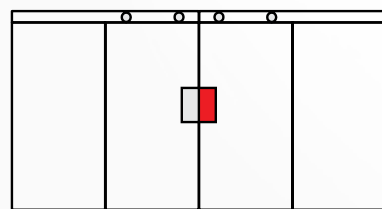

Ref.: 1511-JE
Contra fechadura para fechadura 1510-JD

Aplicação

Recorte

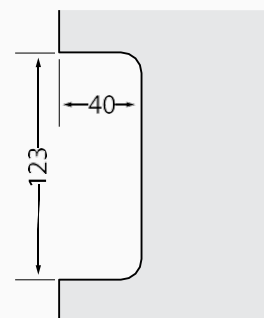
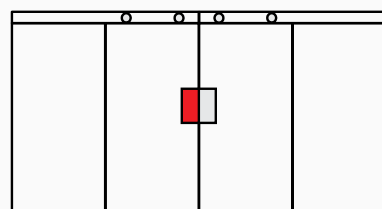

Ref.: 1519
Trinco inferior

Aplicação

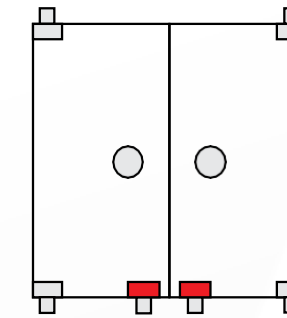

Recorte

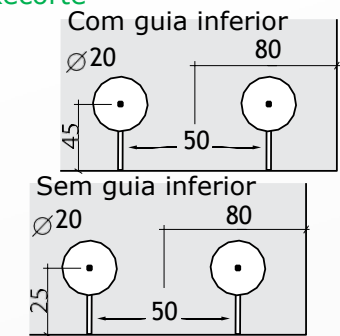

Ref.: 1520
Fechadura para porta de bater

Aplicação

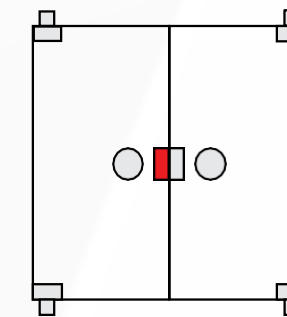

Recorte

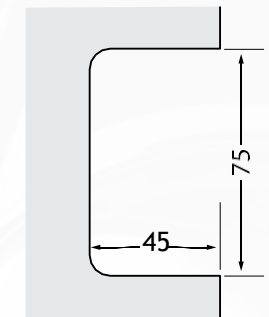

Ref.: 1520-T (tetra)
Fechadura para porta de bater com chave tetra

Aplicação

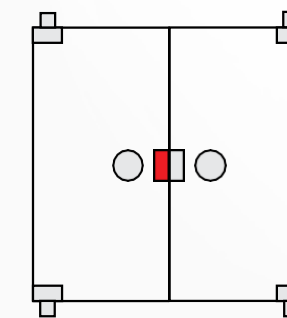

Recorte

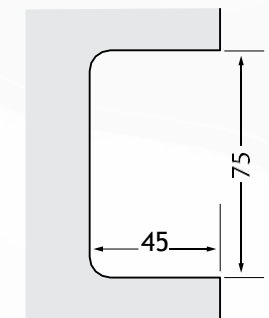

Ref.: 1523
Trinco para basculante

Aplicação

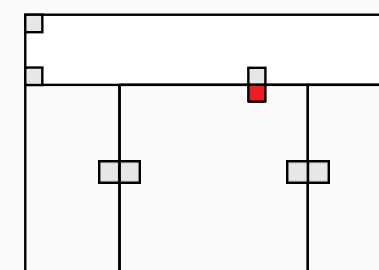

Recorte

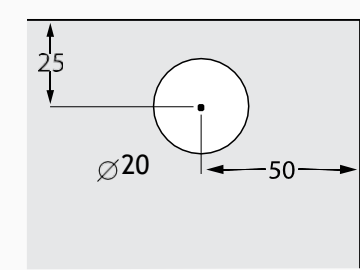

Ref.: 1523-PR
Trinco de pressão para basculante

Aplicação

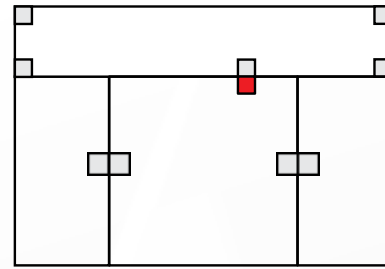

Ref.: 1523-M
Mini trinco para basculante

Aplicação

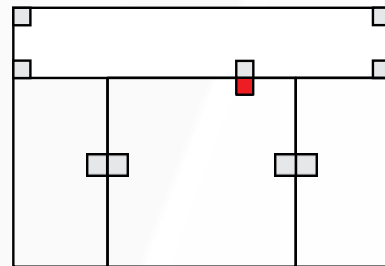

Recorte

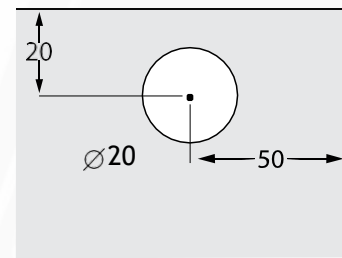

Ref.: 1524
Contra trinco com batente para basculante

Aplicação

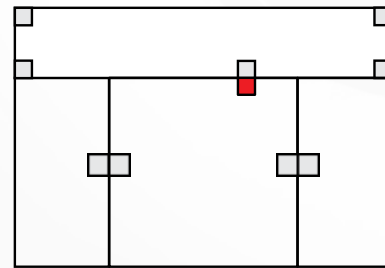

Recorte

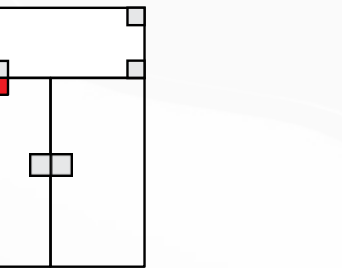

Ref.: 1524
Contra trinco com batente para basculante

Aplicação

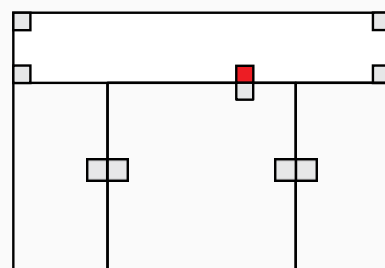

Recorte

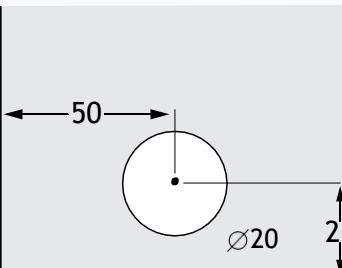

Ref.: 1524 - sem aba
Contra trinco sem batente para basculante

Aplicação

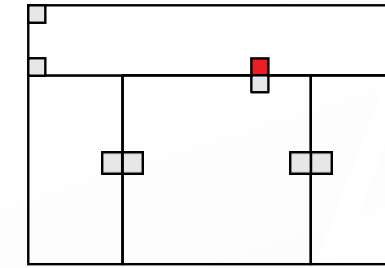

Recorte

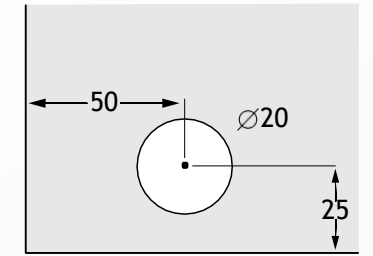

Ref.: 1524-M
Mini contra trinco sem batente para basculante

Aplicação

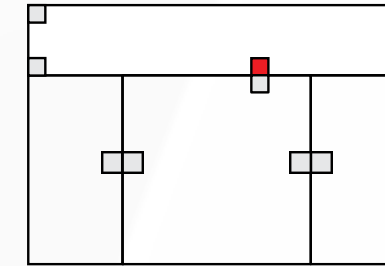

Recorte

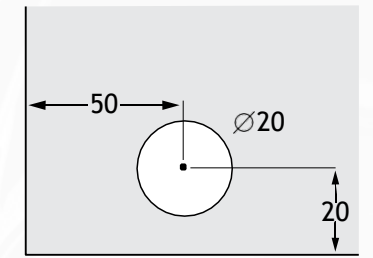

Ref.: 1524-MP
Mini contra trinco de pressão para basculante

Aplicação

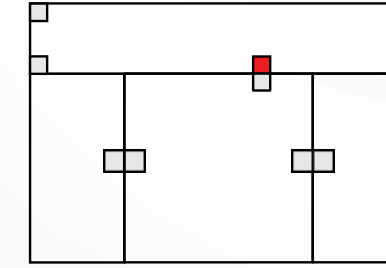

Ref.: 1525
Contra trinco DIREITO para basculante

Aplicação

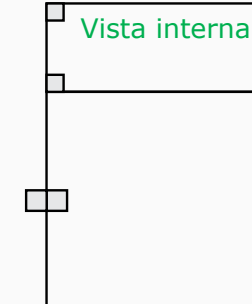

Recorte

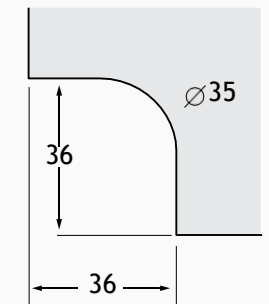

Ref.: 1526
Contra trinco ESQUERDO para basculante



Aplicação

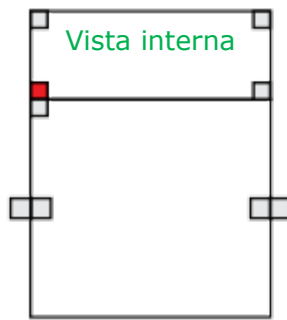

Recorte

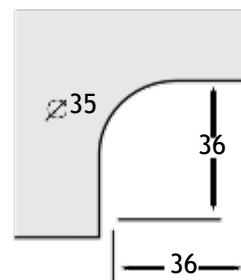

Ref.: 1530-A
Espelho com batente para trinco 1529



Aplicação

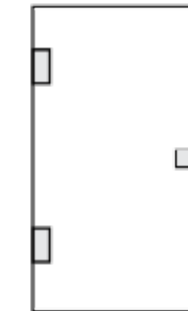

Ref.: 1529
Trinco para porta de bater

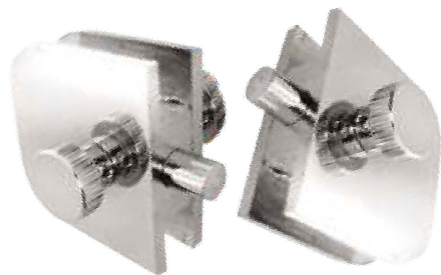

Aplicação

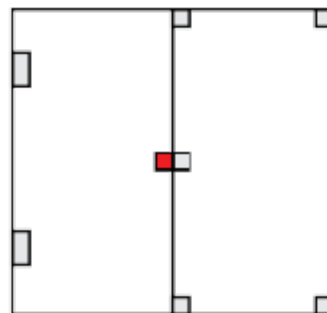

Recorte

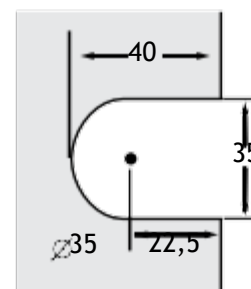

Ref.: 1531
Contra Fechadura com batente para fechadura: 1520/1520-T



Aplicação

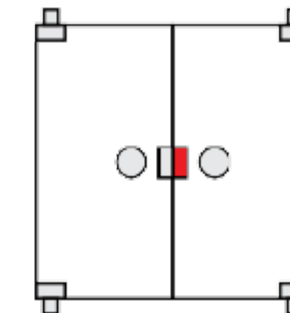

Recorte

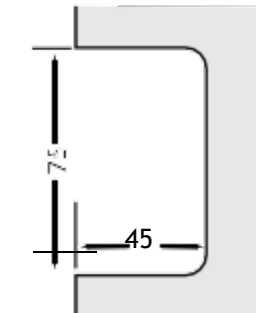

Ref.: 1529-B
Trinco para porta de banheiro público



Aplicação

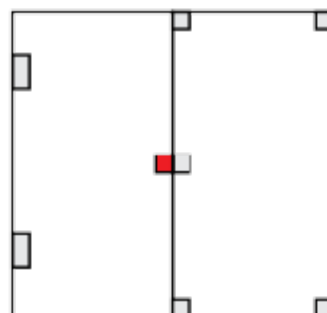

Recorte

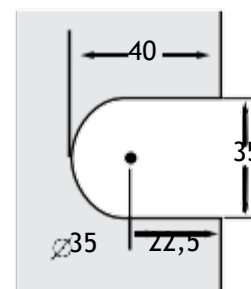

Ref.: 1570
BATE-FECHA - Fecho para janela vidro/vidro



Aplicação

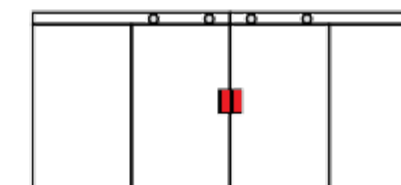

Recorte

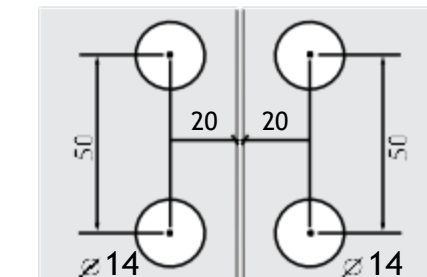

Ref.: 1530
Contra trinco para trinco 1529



Aplicação

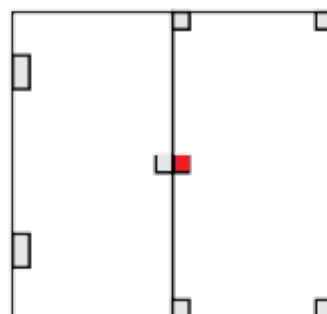

Recorte

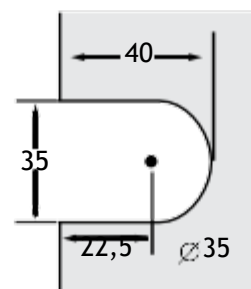

Ref.: 1570-PR
BATE-FECHA - Fecho de pressão para vidro laminado



Aplicação

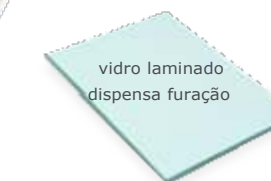

sem recorte

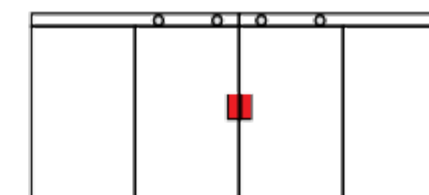



Ref.: 1571
BATE-FECHA - fecho para janela vidro/alvenaria

Aplicação

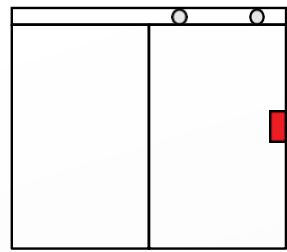

Recorte

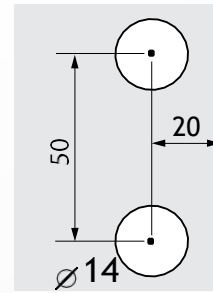

Ref.: 1571-PR
BATE-FECHA - Fecho de pressão para vidro laminado

Aplicação



Recorte

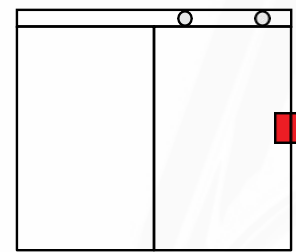

Ref.: 1800
Trinco de pressão



Recorte

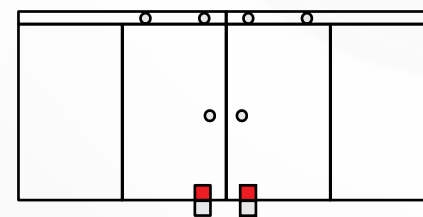

Ref.: 1800-A
Trinco de pressão esquerdo/direito



Recorte

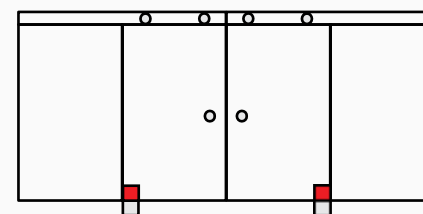

Ref.: 1800-B
Batente de pressão



Aplicação

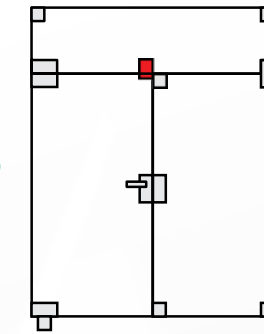

Ref.: 1800-C
Contra trinco de pressão



Aplicação

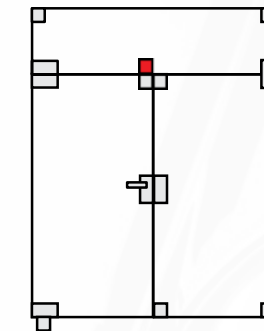

Ref.: 1800-M
Mini trinco de pressão



Aplicação

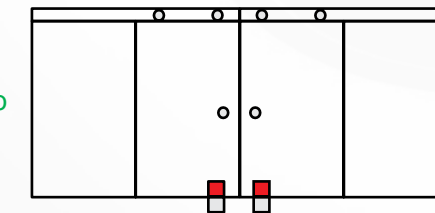

Ref.: 1800-C-MP
Mini contra trinco de pressão



Aplicação

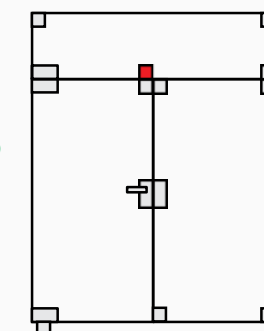



Ref.: 1800-AT
Trinco de pressão lateral

Aplicação

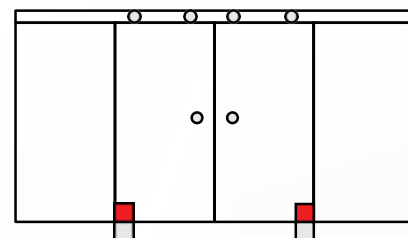

Ref.: 1801
Espelho para trinco 1523

Aplicação

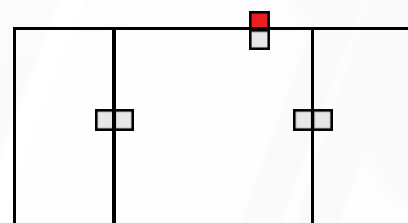

Ref.: 1801-A
Espelho para trinco de piso

Aplicação

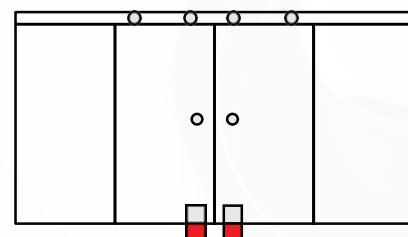

Ref.: 1801-B
Espelho para trinco de piso com furo deslocado

Aplicação

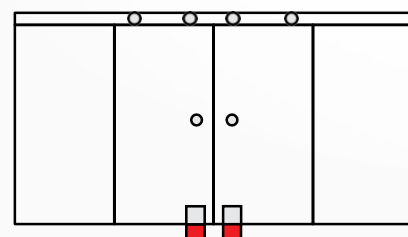

Ref.: 1801-M
Mini espelho para trinco 1523

Aplicação

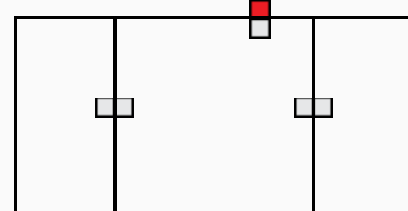

Ref.: 1802
Porta cadeado

Aplicação

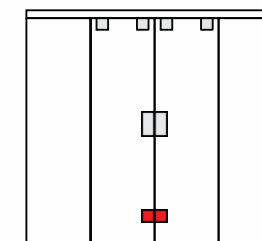

Recorte

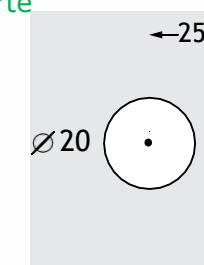

Ref.: 1802-D
Porta cadeado duplo

Aplicação

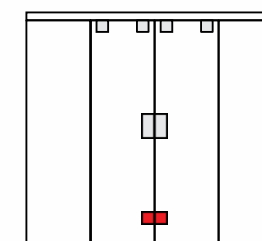

Recorte

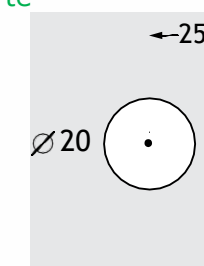

Ref.: 1871
Fixador de porta para rodapé

Aplicação



Ref.: 1872
Fixador de porta para piso

Aplicação



Ref.: 1973-8/10
Suporte para prateleira de 8 e 10mm

Ref.: 3210
Fechadura para porta de bater



Aplicação

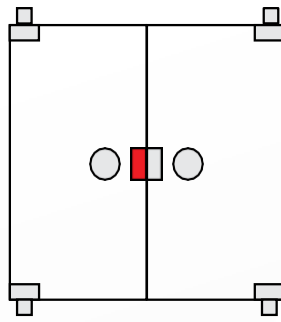

Recorte

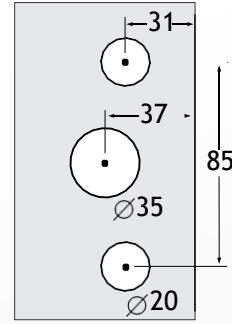

Ref.: 3214
Fechadura sem tambor externo para porta de bater



Aplicação

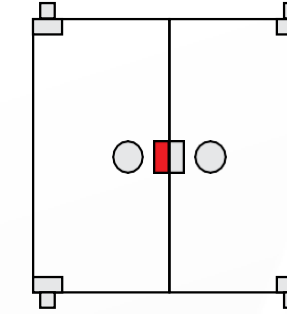

Recorte

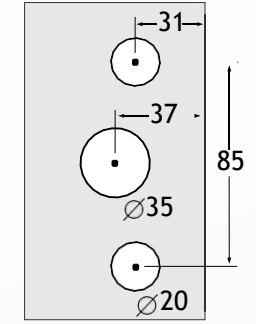

Ref.: 3211
Contra fechadura com batente para fech. 3210 e 3214



Aplicação

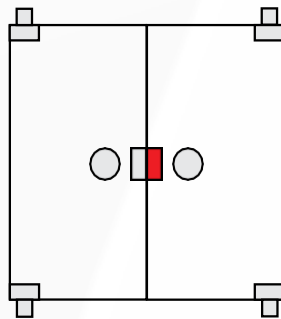

Recorte

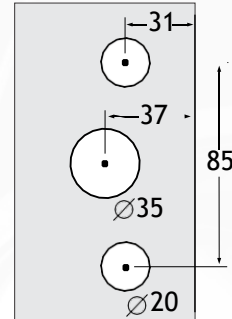

Ref.: 3214-PR
Fechadura de pressão para porta de bater



Aplicação

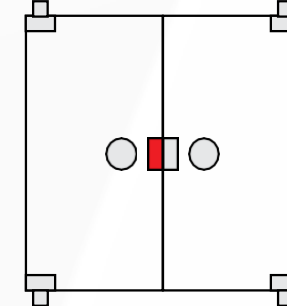

Ref.: 3212
Contra fechadura sem batente para fech. 3210 e 3214



Aplicação

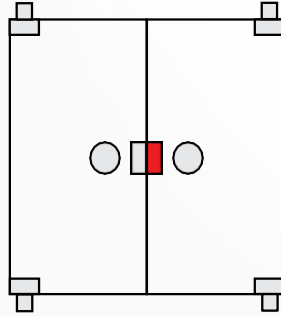

Recorte

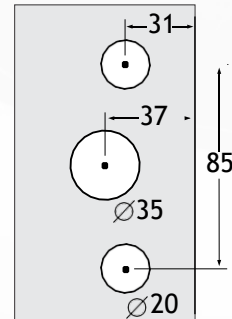

Ref.: 3230
Espelho com batente para fech. 3210, 3214, 3530 e 3532



Aplicação



Aplicação

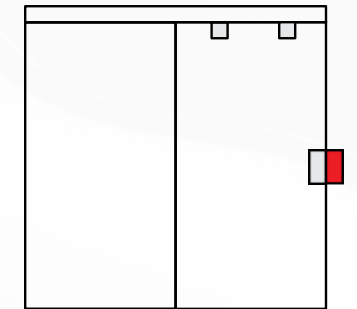

Ref.: 3212-PR
Contra fechadura de pressão para fechadura 3214-PR



Aplicação

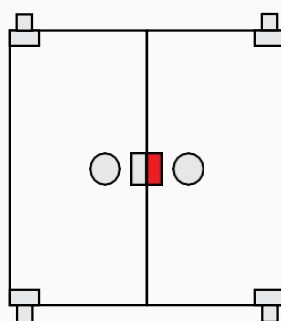

Ref.: 3232
Espelho sem batente para fech. 3210, 3214, 3530 e 3532



Aplicação

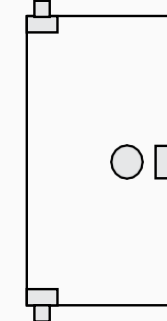

Aplicação

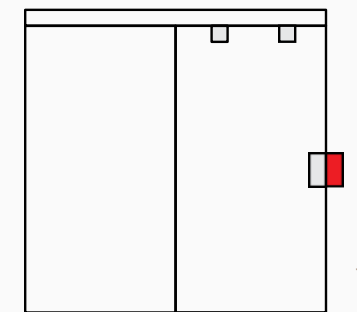

Ref.: 3530
Fechadura para porta de correr



Aplicação

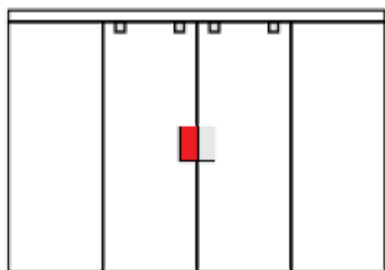

Recorte

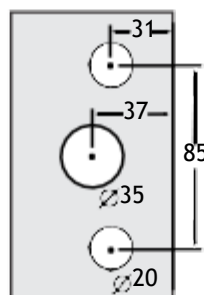

Ref.: 3536
Contra fechadura para fechadura 3532



Aplicação

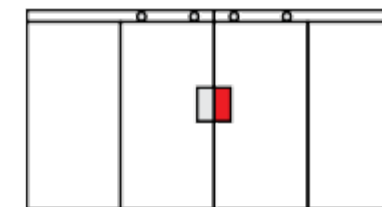

Recorte

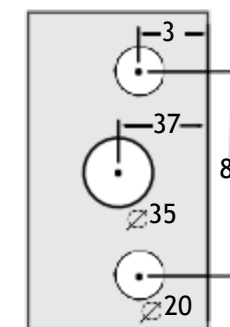

Ref.: 3532
Fechadura sem tambor externo para porta e janela de correr



Aplicação

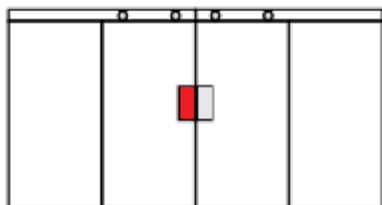

Recorte

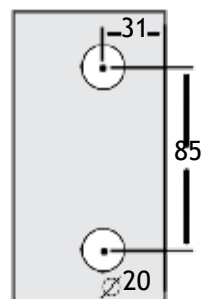

Ref.: 3536-90°
Contra fechadura para fech. 3532 c/ fechamento em 90°



Aplicação

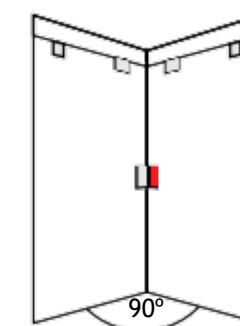

Recorte

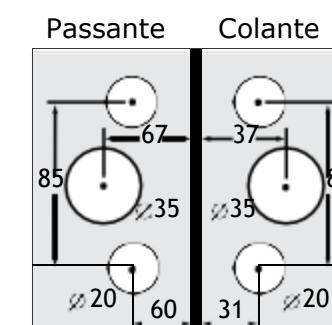

Ref.: 3532-PR
Fechadura de pressão para janela de correr



Aplicação

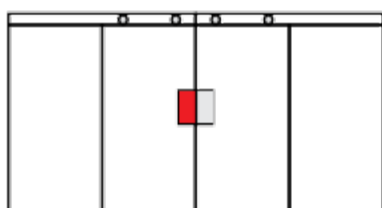

Ref.: 3536-PR
Contra fechadura de pressão para fechadura 3532-PR



Aplicação

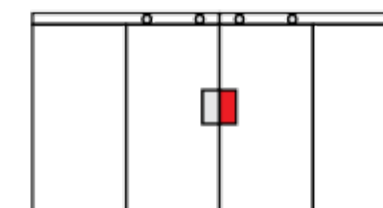

Ref.: 3534
Contra fechadura para fechadura 3530



Aplicação

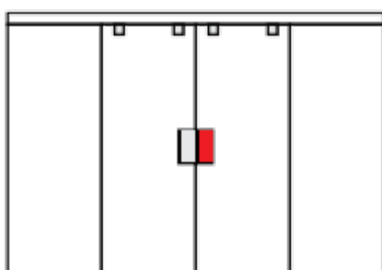

Recorte

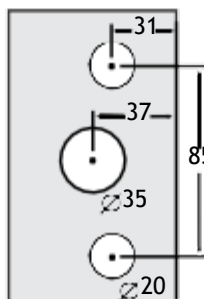

Ref.: 3211-M
Mini contra fechadura com batente para fech. 3214-M



Aplicação

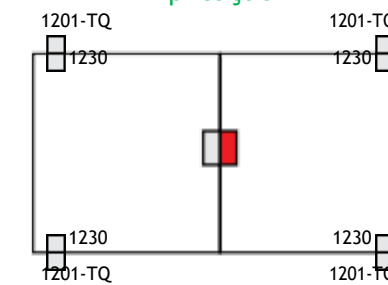

Recorte

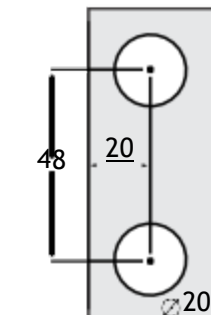



Ref.: 3212-M
Mini contra fechadura sem batente para fech. 3214-M

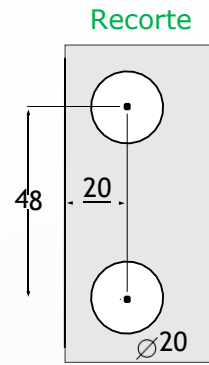
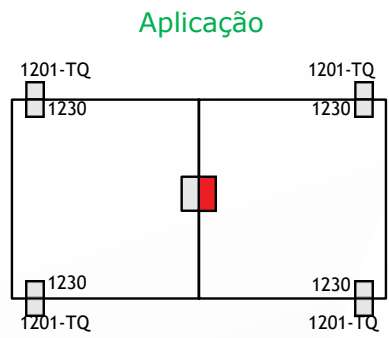

Ref.: 3232-M
Mini espelho sem batente para fechadura 3214-M

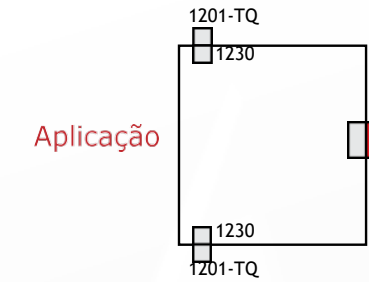

Ref.: 3214-M
Mini fechadura sem tambor externo para janela de bater

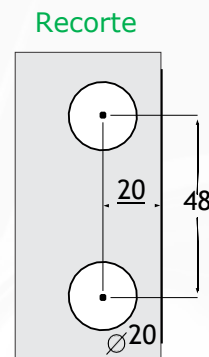
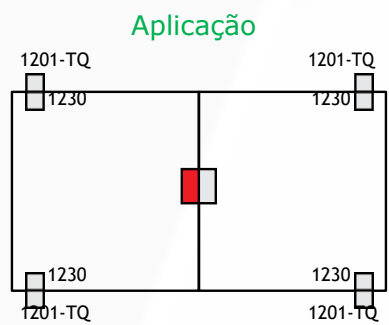

Ref.: 3232-MC
Mini espelho sem batente para fechadura 3532-M



Ref.: 3230-M
Mini espelho com batente para fechadura 3214-M

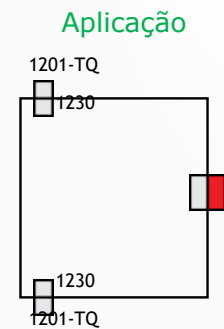

Ref.: 3532-M
Mini fechadura sem tambor externo para janela e vitrine de correr

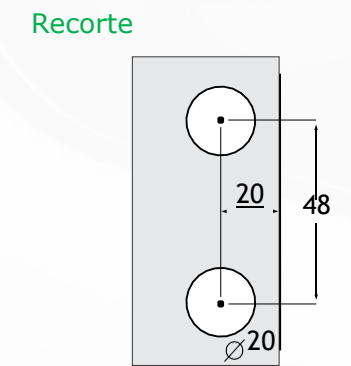
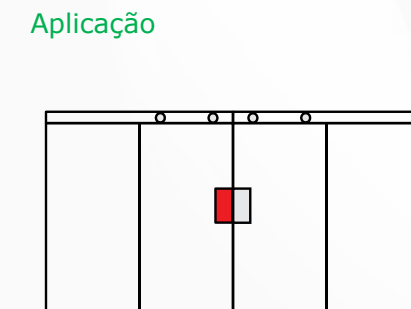

Ref.: 3230-MC
Mini espelho com batente para fechadura 3532-M

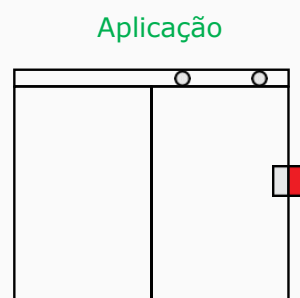

Ref.: 3536-M
Mini contra fechadura para fechadura 3532-M

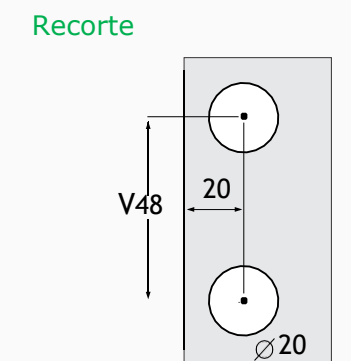
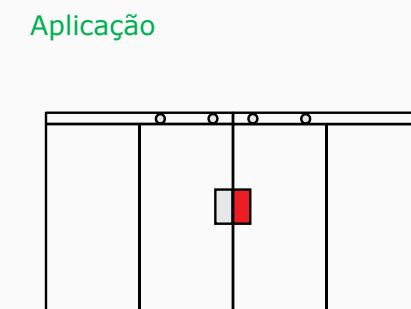

Ref.: PX-CS-30

Puxador curvo simples maciço perfil redondo (300mm entre furos)



Aplicação

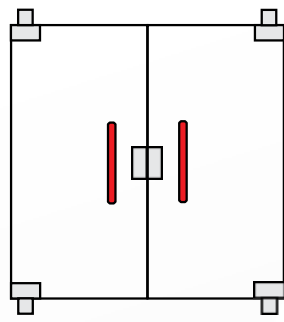

Recorte

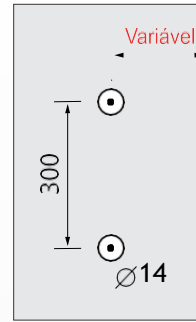

Ref.: PX-RS

Puxador reto simples perfil redondo (200mm a 900mm entre furos)



Aplicação

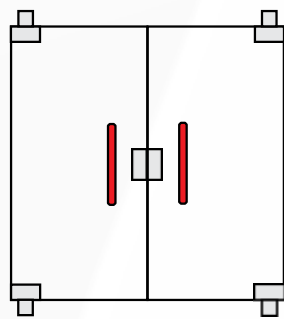

Recorte

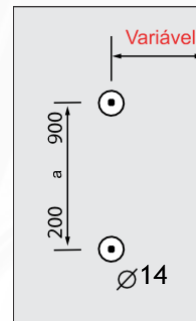

Ref.: PX-RS-RET

Puxador reto simples perfil retangular (200mm a 900mm entre furos)



Aplicação

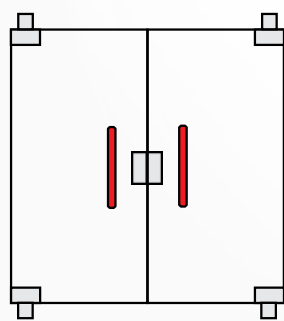

Recorte

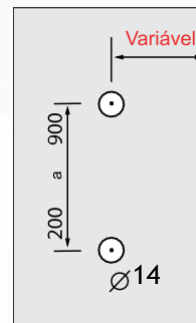

Ref.: PX-RD

Puxador reto duplo perfil redondo (200mm a 900mm entre furos)



Aplicação

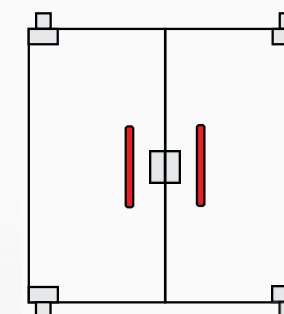

Recorte

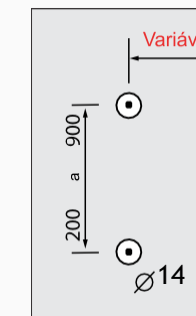

Ref.: PX-CD1-30

Puxador curvo maciço perfil redondo 300mm porta com (um furo) substitui de madeira ou resina



Aplicação

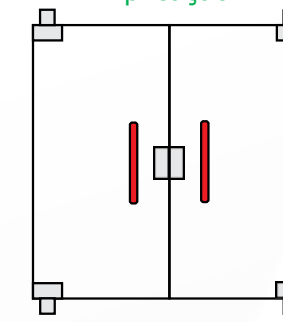

Recorte

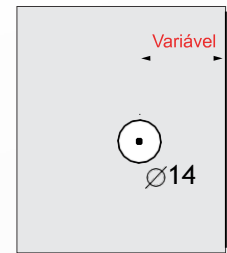

Ref.: PX-CD2-30

Puxador curvo duplo maciço perfil redondo 300mm porta com dois furos (300mm entre furos)



Aplicação

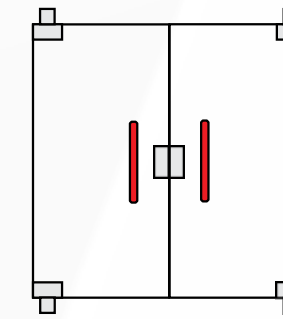

Recorte

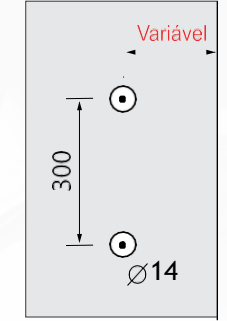

Ref.: PX-CD-30

Puxador curvo duplo maciço perfil redondo (300mm entre furos)



Aplicação

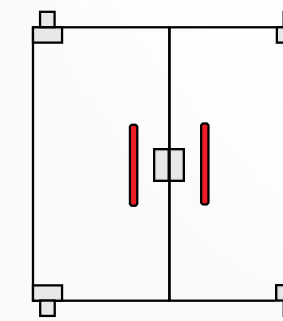

Recorte

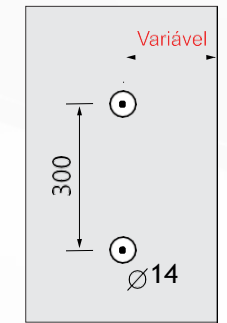

Ref.: PX-RD-RET

Puxador reto duplo perfil retangular (200mm a 900mm entre furos)



Aplicação

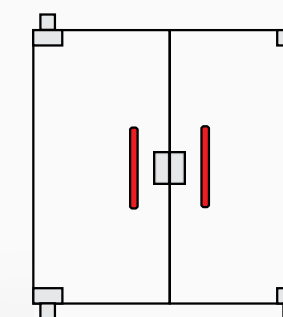

Recorte

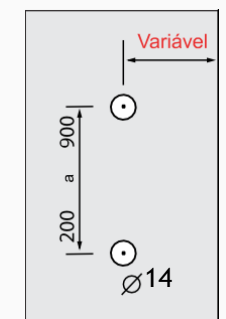

Ref.: 1605
Puxador vidro Temperado (115mm diâmetro)

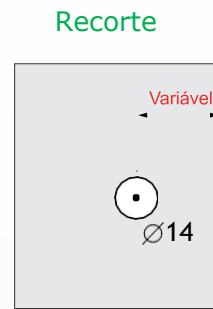
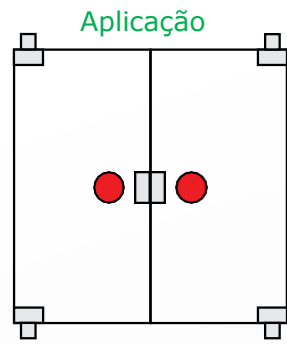

Ref.: 1606
Puxador concha (100mm diâmetro)

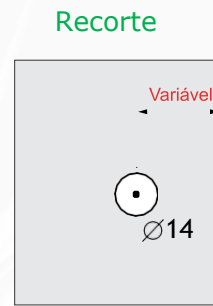
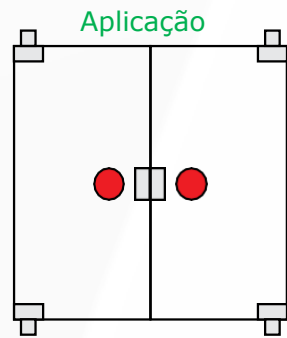

Ref.: 1607
Puxador de madeira

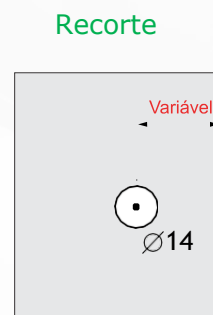
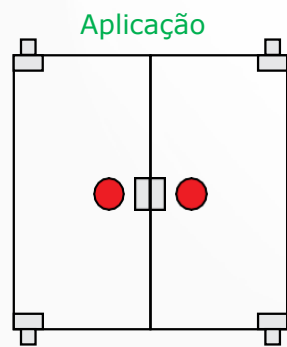

Ref.: 1629-B
Puxador para box

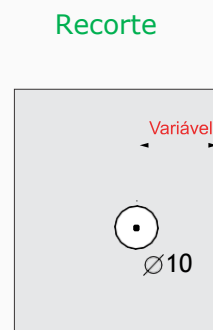
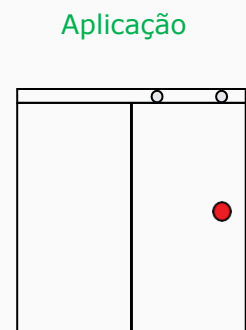

Ref.: 1629-J
Puxador para janela

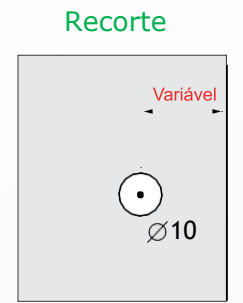
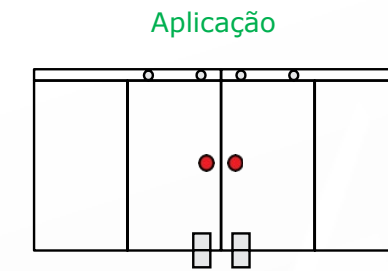

Ref.: 1629-MJ
Mini puxador para armário e janela

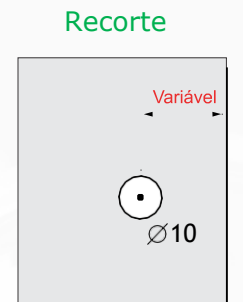
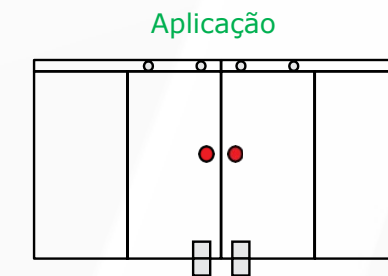

Ref.: 1636
Prolongador para puxador de vidro

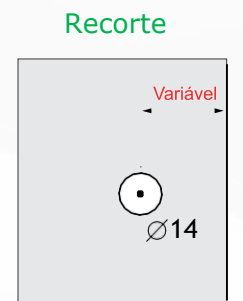
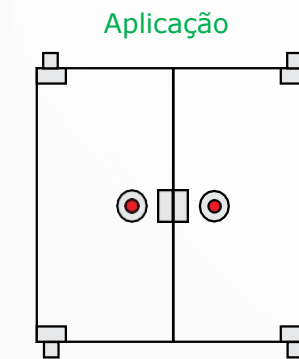

Ref.: 1641
Barra de apoio e segurança em alumínio cromado

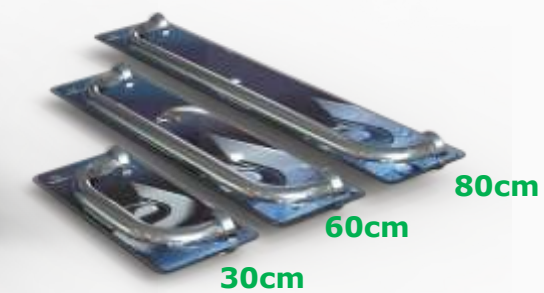



Jogo de pino completo para trincos



Trava com mola para trinco e haste maxim-ar



Pino para dobradiça 1114



Pino para dobradiça 1101



Pinos para trincos



1404 Guia de nylon para porta de correr



Jogo de parafusos com porcas



Miolas para dobradiças: 1103 e 1103-TQ



Pino para 1013



Bucha de nylon para: 1101-TQ/1201/1203/1230



Nylon para dobradiça 1115



Nylon para dobradiça 1114

Prolongadores com tampas

PL-2525	ø25 x 25mm
PL-2550	ø25 x 50mm
PL-25100	ø25 x 100mm
PL-3825	ø38 x 25mm
PL-3850	ø38 x 50mm
PL-38100	ø38 x 100mm

Prolongadores c/ ventosa

PLV-2525	ø25 x 25mm
PLV-2550	ø25 x 50mm
PLV-25100	ø25 x 100mm
PLV-3825	ø38 x 25mm
PLV-3850	ø38 x 50mm
PLV-38100	ø38 x 100mm



ø14

Ref.: PL 5050 PRÓ



Prolongador para Guarda-corpo serviço pesado, 50x50mm com regulagem



Ref.: DVA
Dobradiça Maxim-ar (VA)

Aplicação

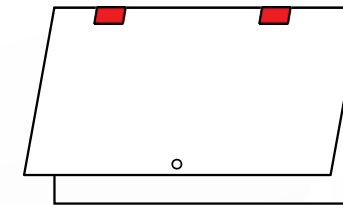

Recorte

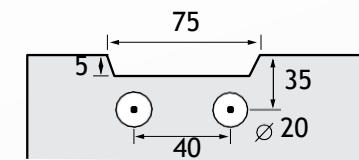

Ref.: DVA-TQ
Dobradiça Maxim-ar (VA) - sem recorte no vidro

Aplicação

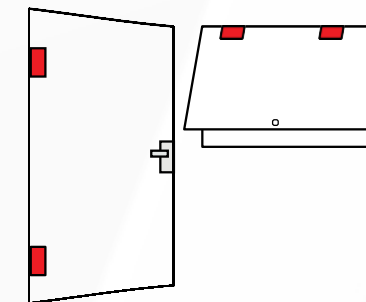

Recorte

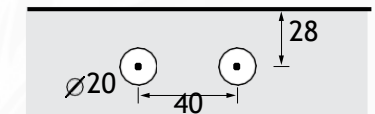

Ref.: DVA-M-TQ
Mini dobradiça Maxim-ar (VA) - sem recorte no vidro

Aplicação

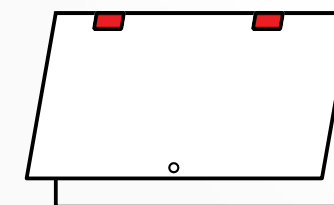

Recorte

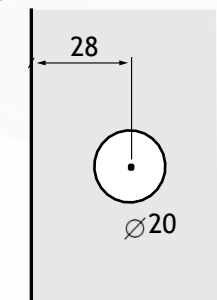

Ref.: DVV
Dobradiça Maxim-ar (VV)

Aplicação

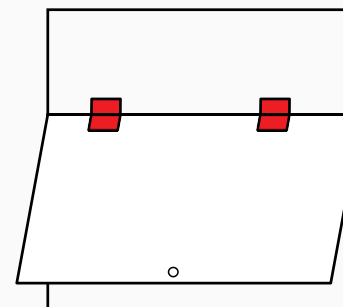

Recorte

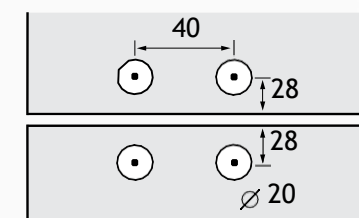

Ref.: Desc-VA
Descanso para haste V/A

Aplicação

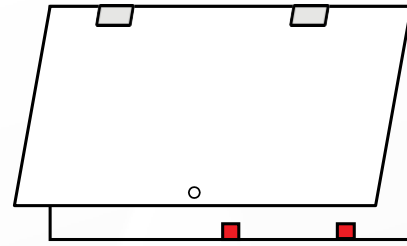

Ref.: Desc-VA-3
Descanso para haste V/A -3

Aplicação

Recorte

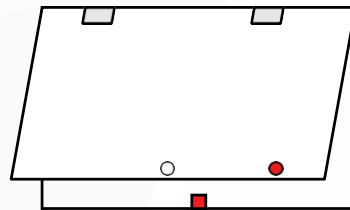

Ref.: Desc-VV
Descanso para haste V/V

Aplicação

Recorte

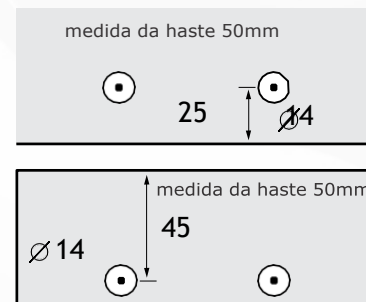
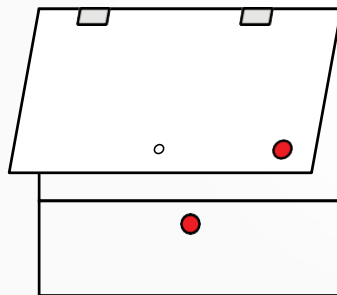

Ref.: Haste Maxim-ar (150mm a 650mm)

Aplicação

Recorte

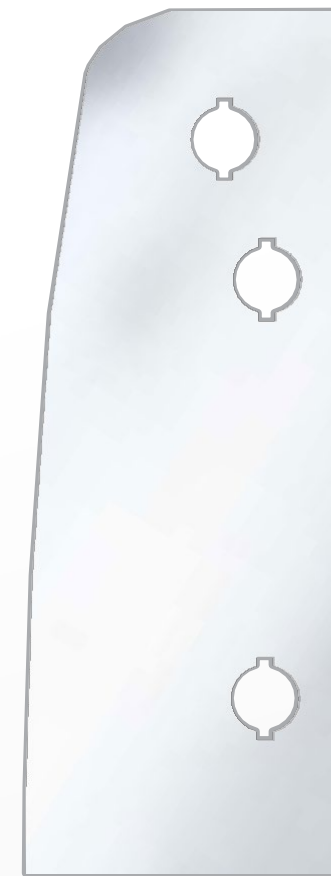
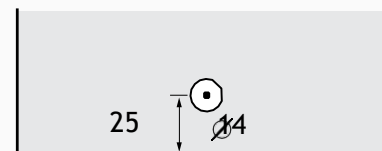
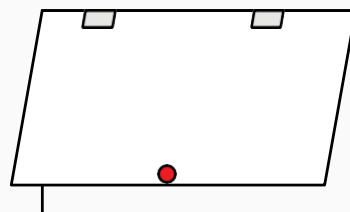

Cromado

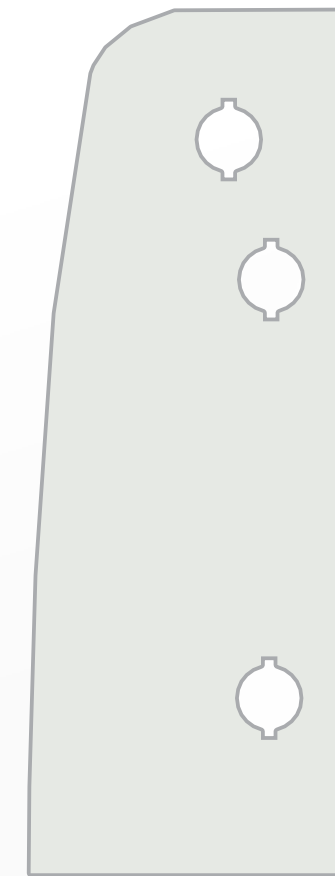

Fosco

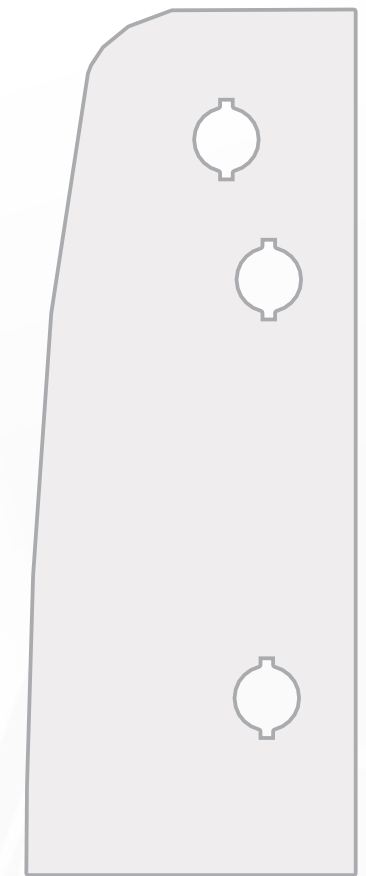

Branco



Preto



Bronze

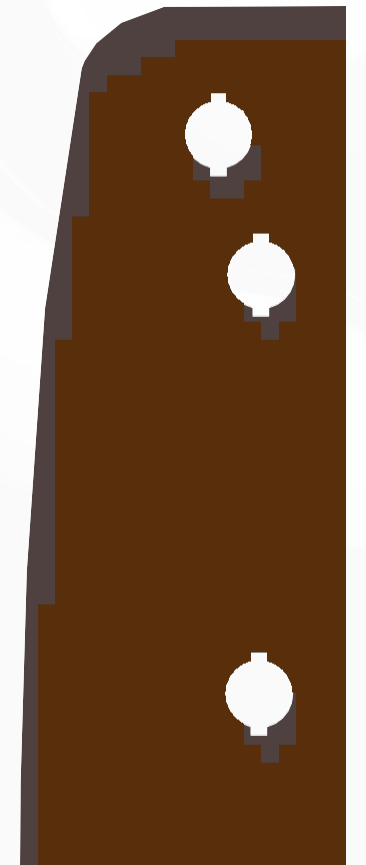

Marrom